



fischer drill bits

The extensive drill bit assortment
for the professional user



Hammer drill Quattric II

The expert for the best performance
in reinforced concrete

Multi-Value drill spiral

Solid carbide metal head

Reinforcement chamfers

Wear mark

Power Shoulder Design



🕒 Discover now **Quattric II**
on page 06

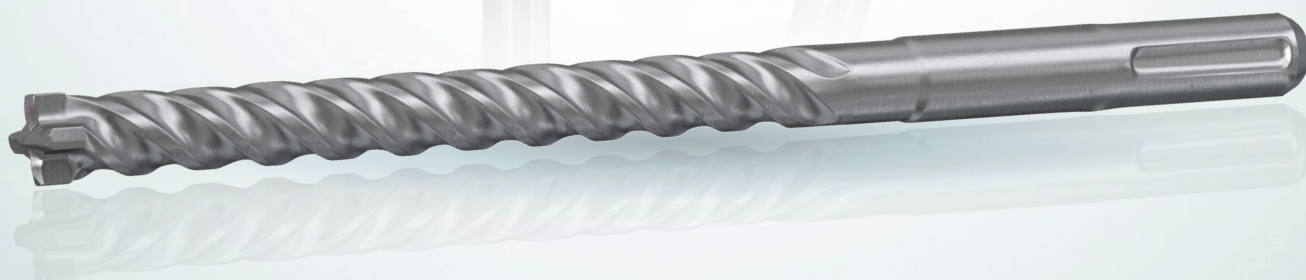

Content

		Page
fischer drill bit assortment		4 – 5
Hammer drill Quattric II		6 – 7
Hammer drill SDS Plus II Pointer		8
Hammer drill SDS Max II / SDS Max IV		9
Chisel		10
Concrete drill bit D-C		11
Stone drill bit D-S		12
Universal drill bit Ultimate Drill D-U		13
Glass drill bit D-GT		14
Metal drill bit D-HSS-Co		15
Metal drill bit D-HSS-G		16
Metal drill bit D-HSS-R		17
Wood drill bit D-WS		18
Auger bit D-WL		19
Forstner drill bit D-WFo		20
Diamond hole saw HS-Di		21
Bi-metal hole saw HS-HSS-Co		22 – 23
Multi-hole saw HS-Multi		24 – 25
Assortment		26 – 43

fischer drill bit assortment

Professional solutions for any building material

Metal
HSS-R / HSS-G

Metal
HSS-Co

Wood

Concrete

Stone

Glass / ceramic





Drill holes in different construction materials can be created with the help of fischer drill bits precisely, economically and, depending on product selection, approval compliant.

Besides high-quality hammer drill bits for the professional user, the assortment also offers straight shank drill bits for the semi-professional user and do-it-yourselfer. It is supplemented with various chisels and hole saws with quick-change chucks.

Different colour coded packaging options ease the choice of the perfect drill bit for any application.



Hammer drill Quattric II

The expert for the best performance in reinforced concrete

Drill-bit head with **Power Shoulder Design**, reinforcement chamfers and wear marks.

New **Multi-Value** drill spiral with **Heavy-Duty Design-Element**.

New **Multi-Value** drill spiral with **Speed-Design-Element**.

Solid carbide metal head.



Your benefits at a glance

- Carbide head (up to \varnothing 10mm) for long service life.
- Power shoulders for improved breakup performance in concrete.
- Massive main cutting edges for quick drilling progress.
- Reinforcement chamfers prevent jamming in the reinforcement.
- Centring tip for simple positioning.
- Wear mark for simple recognition of wear limit in accordance with PGM.
- Two-piece spiral for quick drilling progress and increased service life.



Recommendation

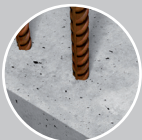

Reinforced concrete

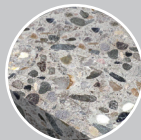

Concrete



Solid brick

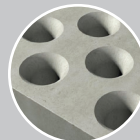

Sandlime brick

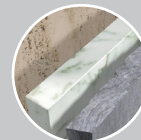

Natural stone

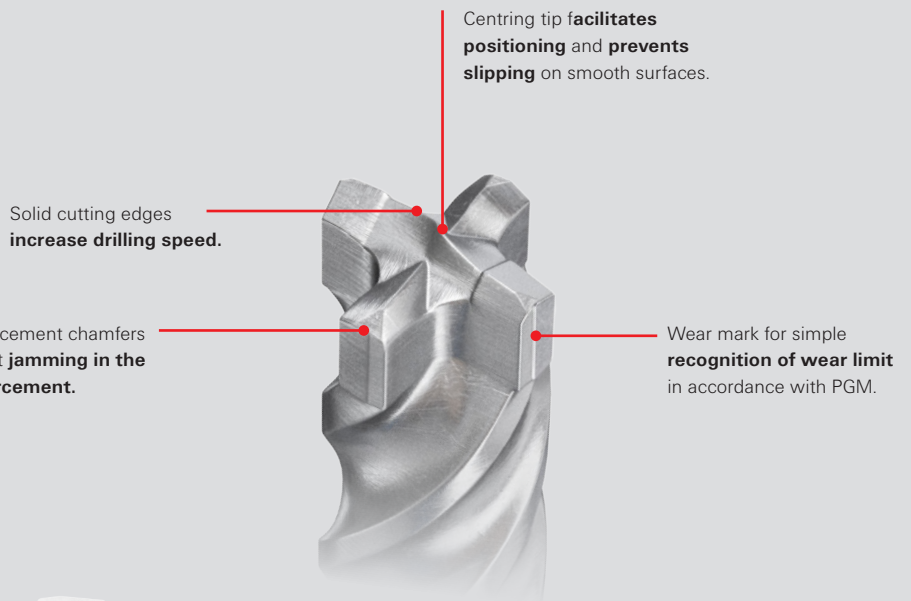
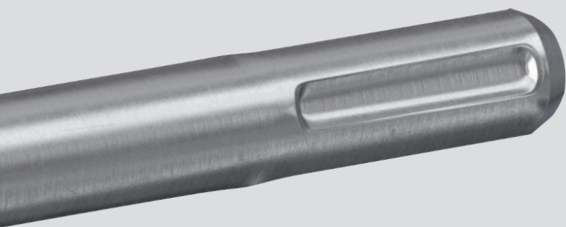

The heavy-duty design element with its strong back width provides a structural reinforcement of the core and **protects against material breakdowns and faster wear.**

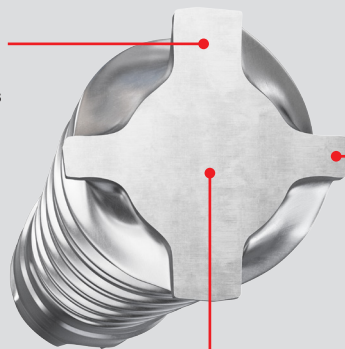

The speed-design element with its lean back side ensures **reduced friction and fast drilling.**

Reinforced core element for **a higher service life.**

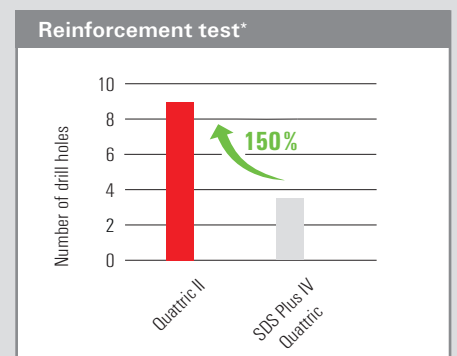
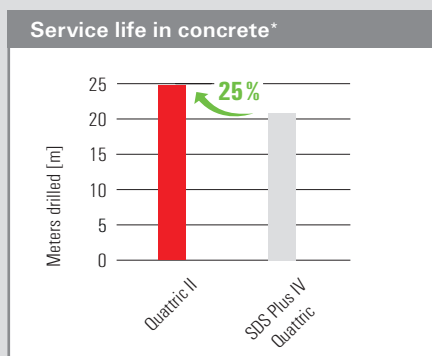
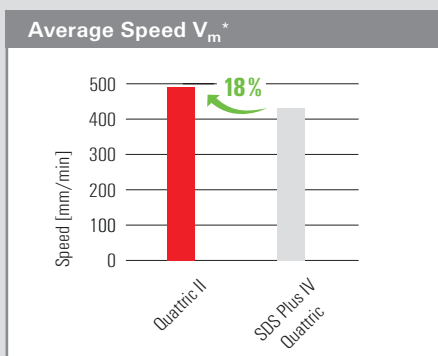

* Tests with Quattric II 10x160 in concrete C45/55 0-16 with H22SLE

Hammer drill SDS Plus II Pointer

The two-flute cutter is setting new standards when it comes to drilling speed

Centring tip **facilitates positioning** and **prevents slipping** on smooth surfaces.

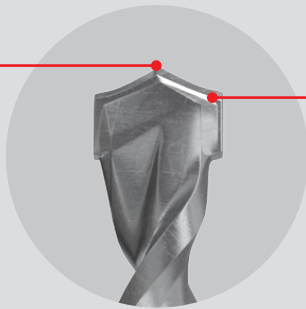

Larger, patented reinforcement chamfers **reduce the probability of jamming** for reinforcement hits.

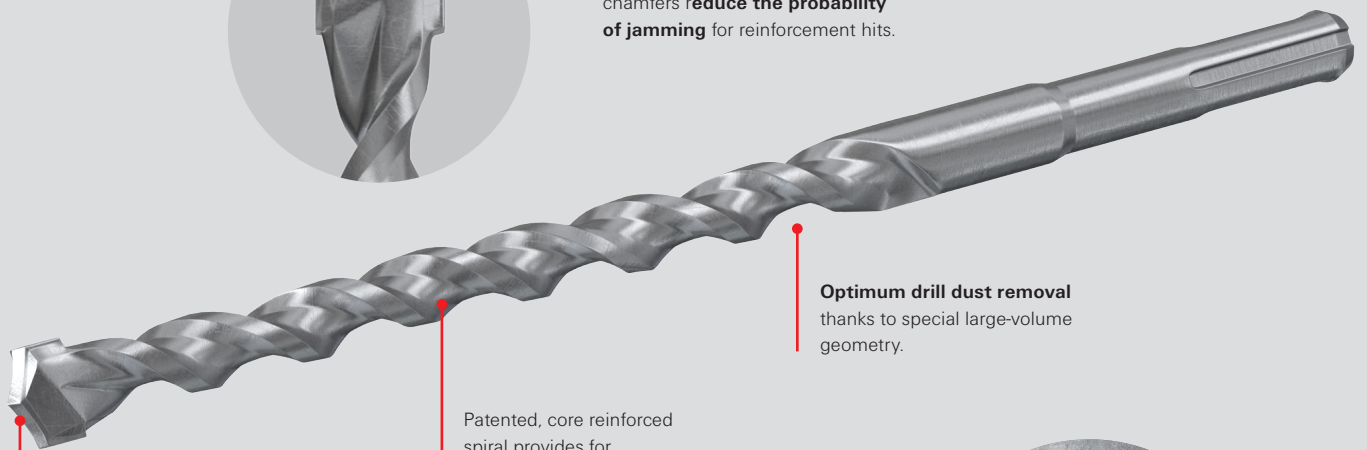

Optimum drill dust removal thanks to special large-volume geometry.

Patented, core reinforced spiral provides for a **higher service life**.

Power breakers cause micro-tears in the material to be drilled and provide **better drilling speed**.



Your benefits at a glance

- Power breakers cause micro-tears in the material to be drilled and provide better drilling speed.
- Larger reinforcement chamfers reduce the probability of jamming for reinforcement hits.
- Optimum drill dust removal thanks to the Vario spiral.
- The spiral geometry increases stability and break resistance.
- The optimized drill geometry allows for rapid drilling progress reduced wear and less effort.
- Centring tip facilitates positioning and prevents slipping on smooth surfaces.



Recommendation



Concrete



Solid brick



Natural stone

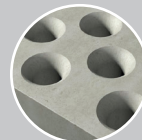

Sandlime brick

Hammer drill SDS Max II / SDS Max IV

The hammer drill bits with SDS Max drill chuck

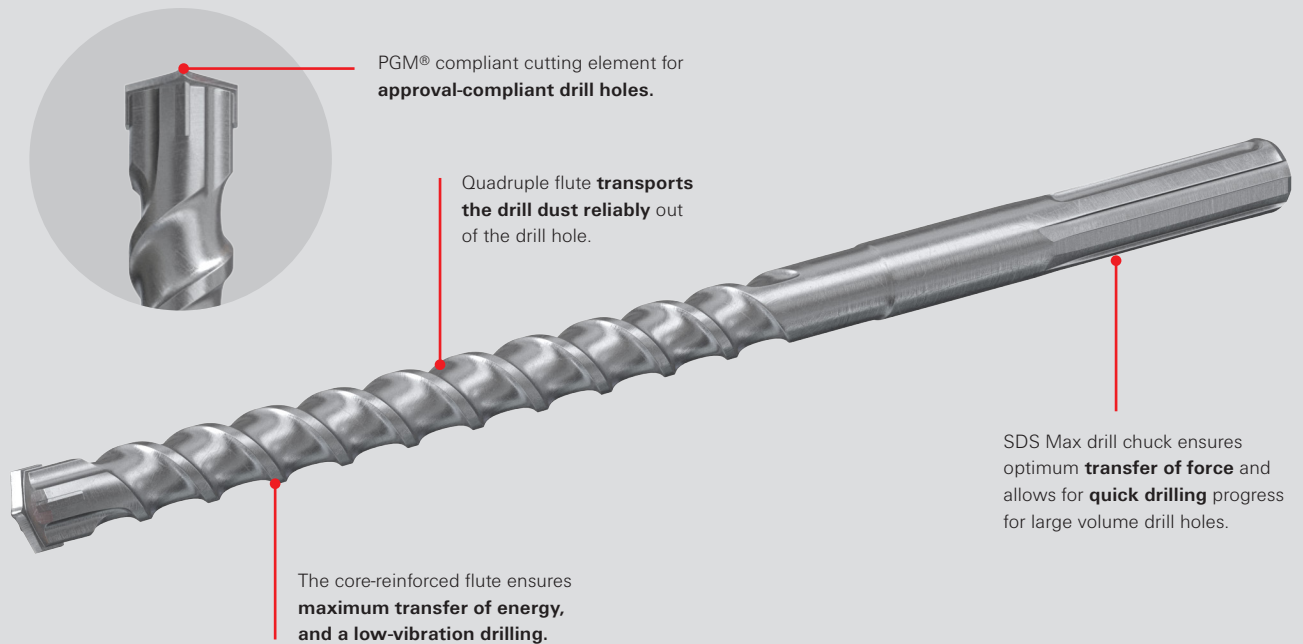

Your benefits at a glance

- SDS Max drill chuck ensures optimum transfer of force and allows for quick drilling progress.
- Drill head with four cutting edges prevents jamming in the reinforcement.
- Quadruple flute transports the drill dust reliably out of the drill hole thus reducing wear.
- The core-reinforced flute ensures maximum transfer of energy, and guarantees low-vibration drilling.
- PGM® compliant cutting element guarantees perfect drill holes to fulfil highest safety requirements.

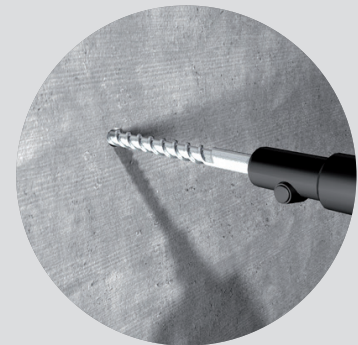

Recommendation

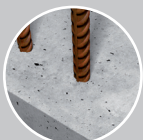

Reinforced concrete
(SDS Max IV)

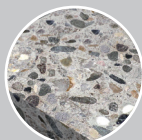

Concrete



Solid brick



Natural stone

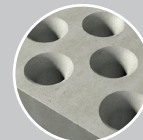

Sandlime brick

Chisel

High-performance chisel with SDS Plus and SDS Max drill chuck



Gouge chisel

For the **profiling of small cable or pipe channels** in concrete.

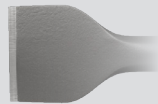

Spade chisel

For the **universal removal of material** in a larger volume.



Tile chisel

For the quick and easy **removal of Tile scaling**.

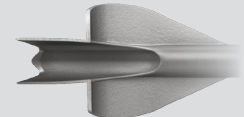

Wing bit

For **inserting ducts**. Bearing surface and angle enable an **even duct depth**.



Channel chisel

For the **profiling of small channels** in masonry.



Tooth chisel

For **renovating masonry**, as well as removing joints or intact stones from the wall.



Sharp chisel

For general **chiselling and excavation** work of masonry, concrete and loose stones.



Flat chisel

For general **chiselling and excavation work** of masonry, concrete and loose stones. Is used to apply targeted refractive power.

Your benefits at a glance

- The SDS Plus and SDS Max drill chuck for the chisel allow for use with professional hammer drilling machines, and ensure a proven and safe transfer of force.
- The use of a high quality, specially hardened steel with surface protection increases the life span of the tools.
- The high oscillation endurance allows for high work comfort and contributes to the achievement of clean results.

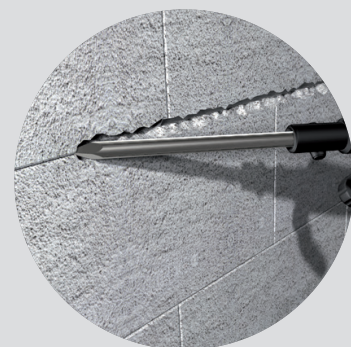

Recommendation



Concrete



Masonry



Natural stone



SDS Plus



SDS Max

Concrete drill bit D-C

Robust concrete drill bit with carbide tip

130° carbide tip for long **service life**,
extremely heat resistant.

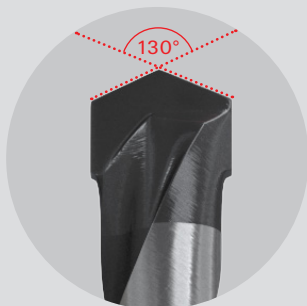

Milled in accordance
with **DIN 8039.**

Robust version with
high break resistance.

Suitable for **rotary and
impact drilling.**

Optimum drill dust removal
thanks to special spiral
geometry.



Your benefits at a glance

- 130° carbide cutting edge for long service life, extremely heat resistant.
- Robust version in accordance with DIN 8039, milled, with high break resistance.
- Optimum drill dust removal through special spiral geometry.
- Suitable for rotary and impact drilling.

**DIN
8039**

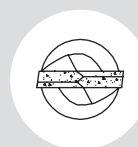

130°

Recommendation



Concrete



Masonry

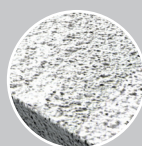

Aerated concrete



Stone

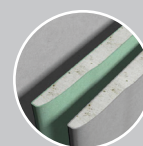

Gypsum plasterboard

Stone drill bit D-S

Universal masonry drill bit for impact and rotary drilling in masonry and natural stone

130° carbide tip for **long service life, very heat resistant.**

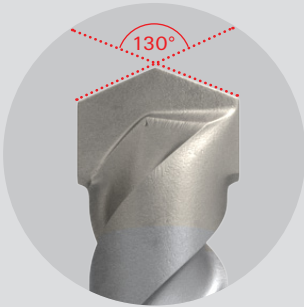

Robust version roll forged in accordance with **DIN 8039.**

Suitable for **rotary and impact drilling.**

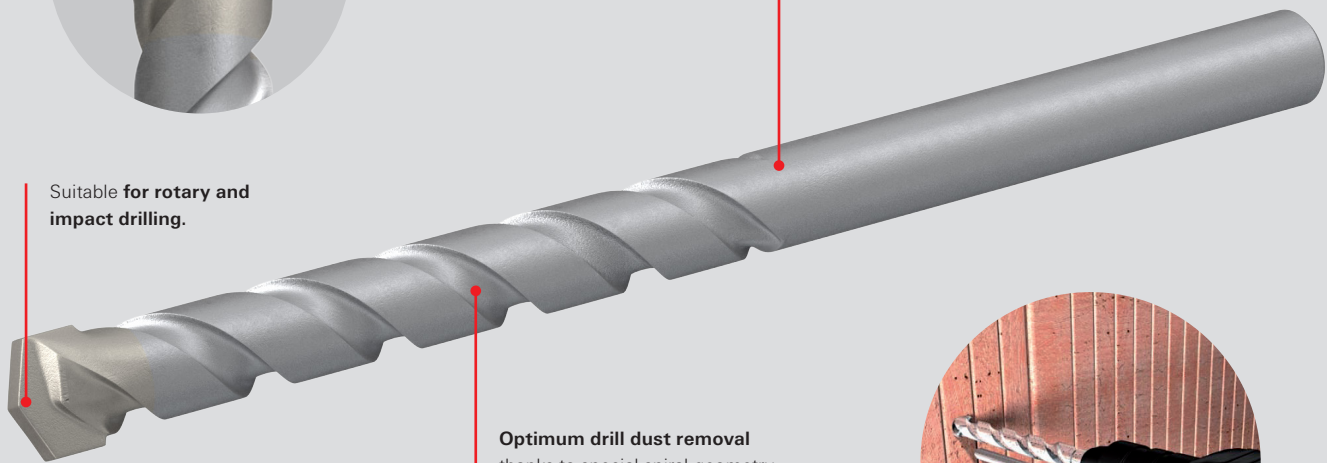

Optimum drill dust removal thanks to special spiral geometry.



Your benefits at a glance

- 130° carbide cutting edge for long service life, very heat resistant.
- Robust version in accordance with DIN 8039, roll forged.
- Optimum drill dust removal through special spiral geometry.
- Suitable for rotary and impact drilling.

**DIN
8039**

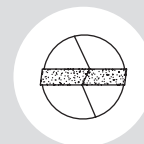

Recommendation



Masonry

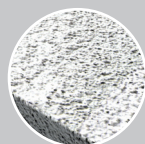

Aerated concrete



Stone

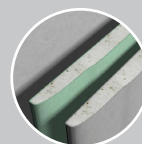

Gypsum plasterboard

Universal drill bit Ultimate Drill D-U

Universal drill bit with extremely sharp carbide tip

Extremely sharp, specially ground carbide tip, **ideally suited for drilling in material combinations.**

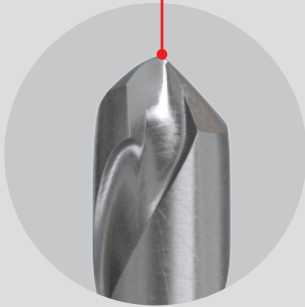

High-quality soldering ensures **extreme heat resistance.**

Special grind of the carbide tip for **fast pilot drilling**, which makes it particularly **suitable for battery-operated machines.**

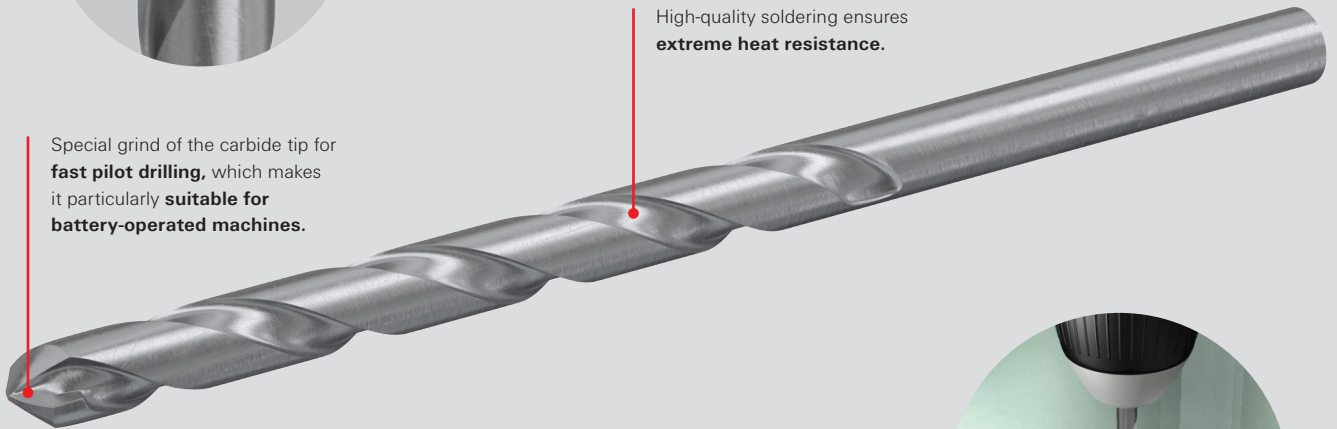

Your benefits at a glance

- Extremely sharp, specially ground carbide tip, ideally suited for drilling in material combinations.
- Extremely heat-resistant thanks to the high-quality soldering
- Special grind of the carbide tip for quick pilot drilling. This makes it particularly suitable for battery-operated machines.
- Universally applicable in various building materials.

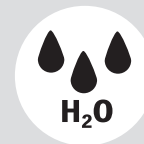

Recommendation



Tile

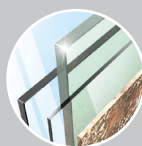

Glass

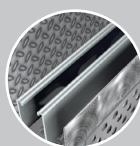

Metal

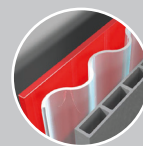

Plastic

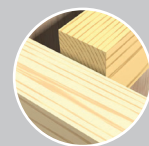

Wood

Glass drill bit D-GT

Glass and tile drill bit with carbide cutting edge

Specially ground 120° carbide tip enables the drilling in **hard materials**.

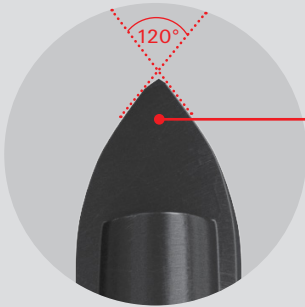

Cone point for **precision pilot drilling**.

Best drilling results are achieved at low speeds and sufficient cooling with water, turpentine, vinegar or petroleum.

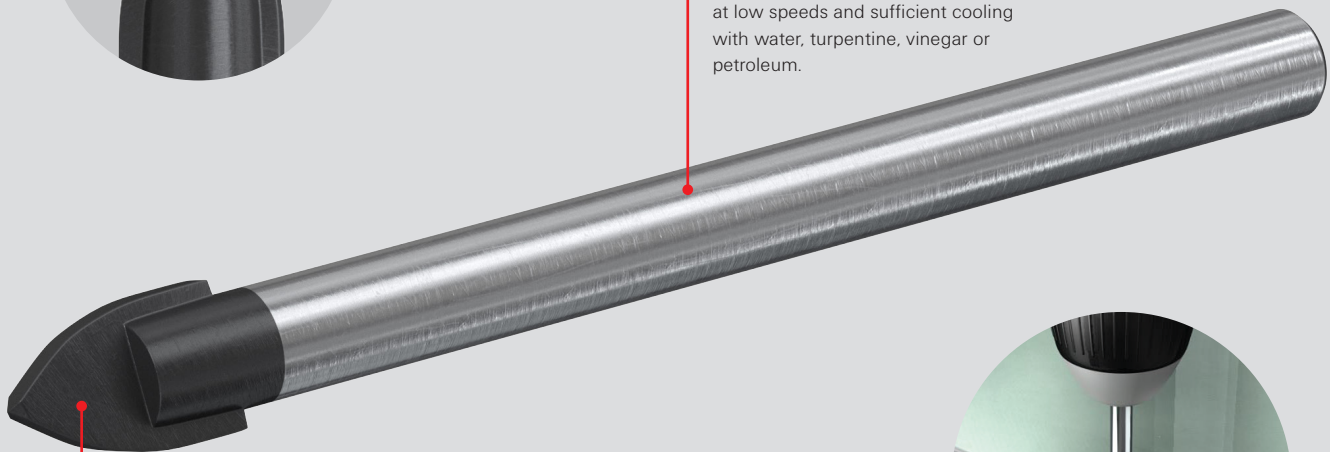

Carbide tip for long **service life** and **extreme heat-resistance**.

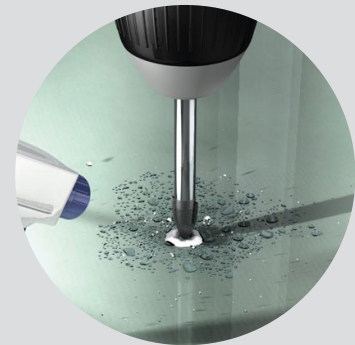

Your benefits at a glance

- Specially ground 120° carbide tip enables the processing of hard materials.
- Cone point for precision pilot drilling on glass and Tile.
- Carbide tip for long service life and extreme heat resistance.

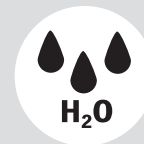

Recommendation



Tile scaling

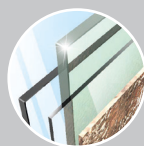

Glass

Metal drill bit D-HSS-Co

Precision ground metal twist drill bit

135° tip angle (from 3mm) for quick drilling progress.

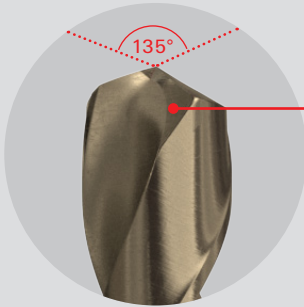

Split point for optimum centring and little feed force effort.

Ground in accordance with DIN 338.

Made of robust HSS steel.

Robust drill bit with high break resistance.

Precision ground from solid stock for long service life and precision.

Thanks to the cobalt alloy (5% Co), it is highly heat-resistant and suitable for hard and tough materials.

Optimum chip removal with type N spiral.



Your benefits at a glance

- Made of cobalt-alloyed special steel in accordance with DIN 338.
- Thanks to the cobalt alloy, it is highly heat-resistant and suitable for tough and hard materials.
- Robust drill bit with high break resistance.
- Split point for optimum centring and little feed force effort.
- 135° tip angle for quick drilling progress.
- Optimum chip removal through type N spirals.

DIN
338



135°



STAINLESS

Recommendation

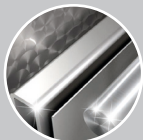

Stainless steel

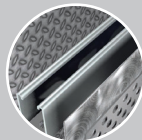

Metal

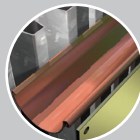

Non-ferrous metal

Metal drill bit D-HSS-G

High-quality metal twist drill bit

135° tip angle (from 3mm) for quick drilling progress.

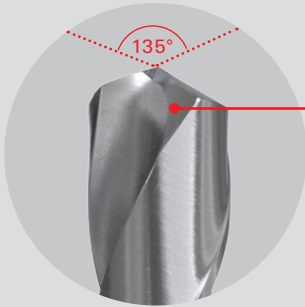

Split point for optimum centring and little feed force effort.

Ground in accordance with DIN 338.

Made of robust HSS steel.

Robust drill bit with high break resistance.

Precision ground from solid stock for long service life and precision.

Optimum chip removal with type N spiral.



Your benefits at a glance

- Made of robust HSS steel and in accordance with DIN 338.
- Robust drill bit with high break resistance.
- Precision ground from solid stock for long service life and high precision.
- Split point for optimum centring and little feed force effort.
- 135° tip angle for quick drilling progress.
- Optimum chip removal through type N spirals.

DIN
338



135°



Recommendation

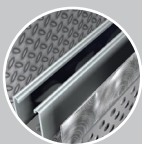

Metal

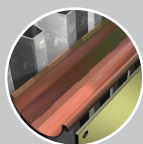

Non-ferrous metal

Metal drill bit D-HSS-R

High-performance metal twist drill bit

118° tip angle for **better heat removal and precise pilot drilling.**

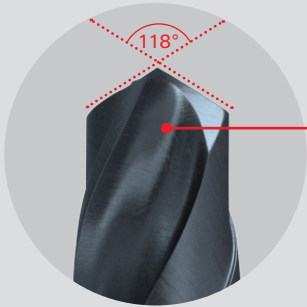

Chisel edge with strong side edges, **insensitive to lateral forces.**

Made of **robust HSS steel.**

Roll forged in accordance with **DIN 338.**

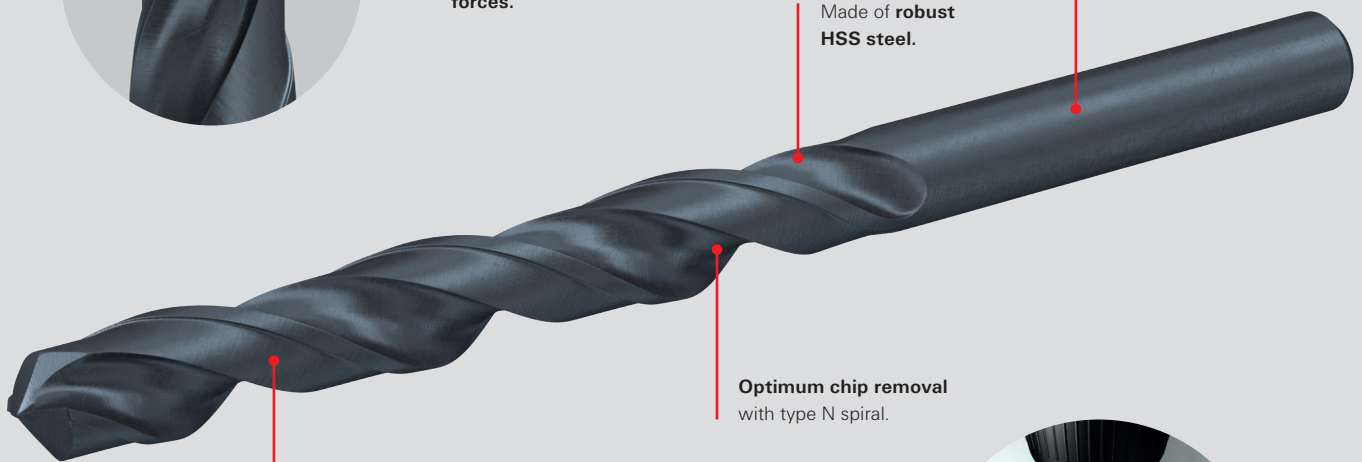

Robust drill bit with **high break resistance.**

Optimum chip removal with type N spiral.



Your benefits at a glance

- Made of robust HSS steel and in accordance with DIN 338.
- Robust drill bit with high break resistance.
- Chisel edge with strong side edges, insensitive to lateral forces.
- 118° tip angle for better heat removal and precise pilot drilling.
- Optimum chip removal through type N spirals.

**DIN
338**

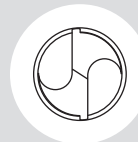

118°



Recommendation

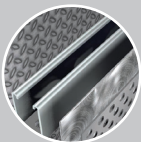

Metal

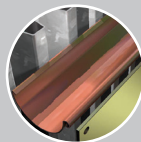

Non-ferrous metal

Wood drill bit D-WS

Wood twist drill bit with centring tip

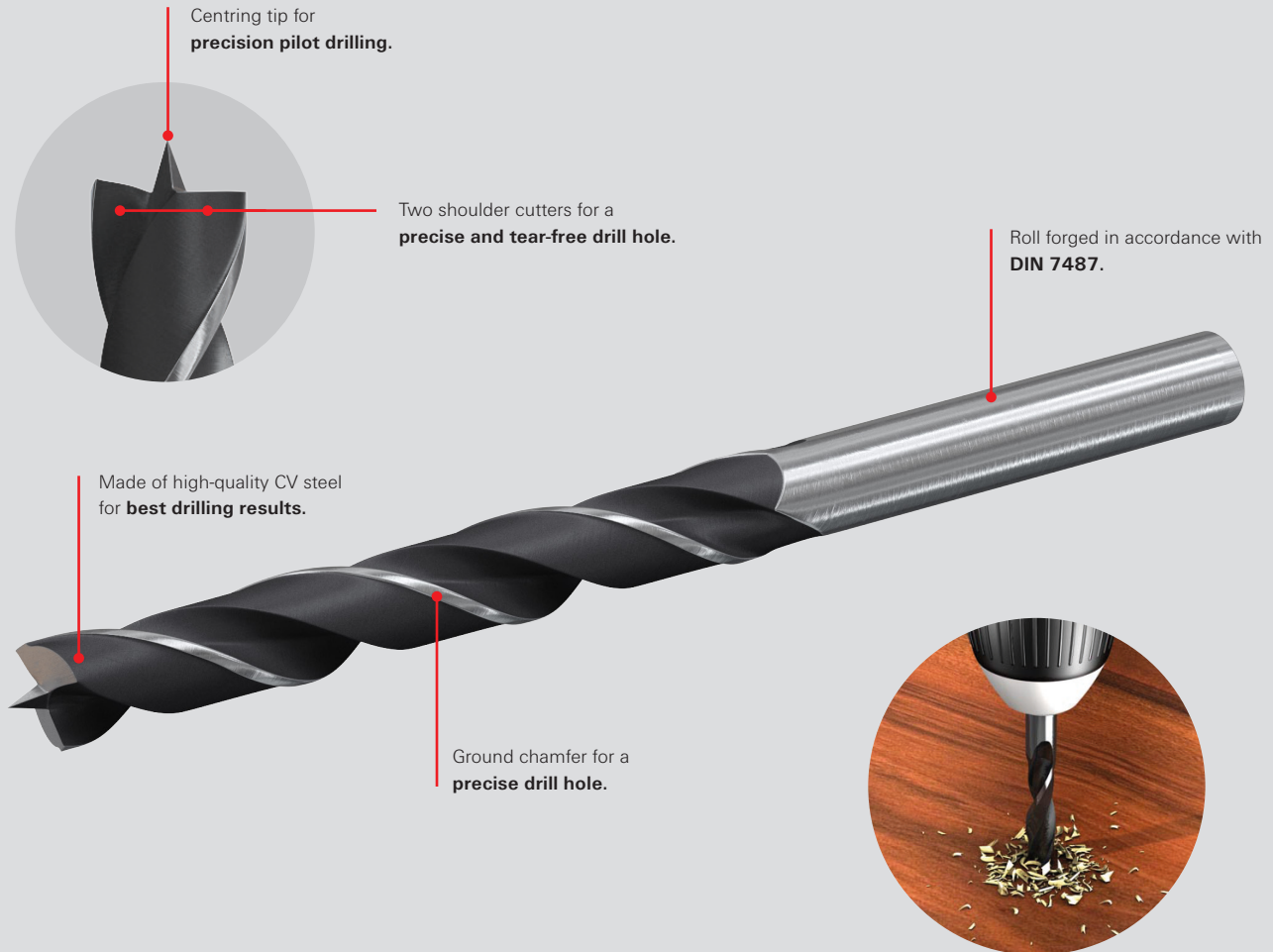

Your benefits at a glance

- Centring tip for precision pilot drilling.
- Made of high-quality CV steel for best drilling results.
- Two shoulder cutters for a clean and tear-free drill hole.
- With a ground chamfer for a precise drill hole.

**DIN
7487**



Recommendation



Hard- and soft wood



Lightweight
construction materials

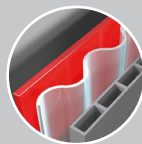

Plastic

Auger bit D-WL

Auger bit with hexagonal shank and centring tip

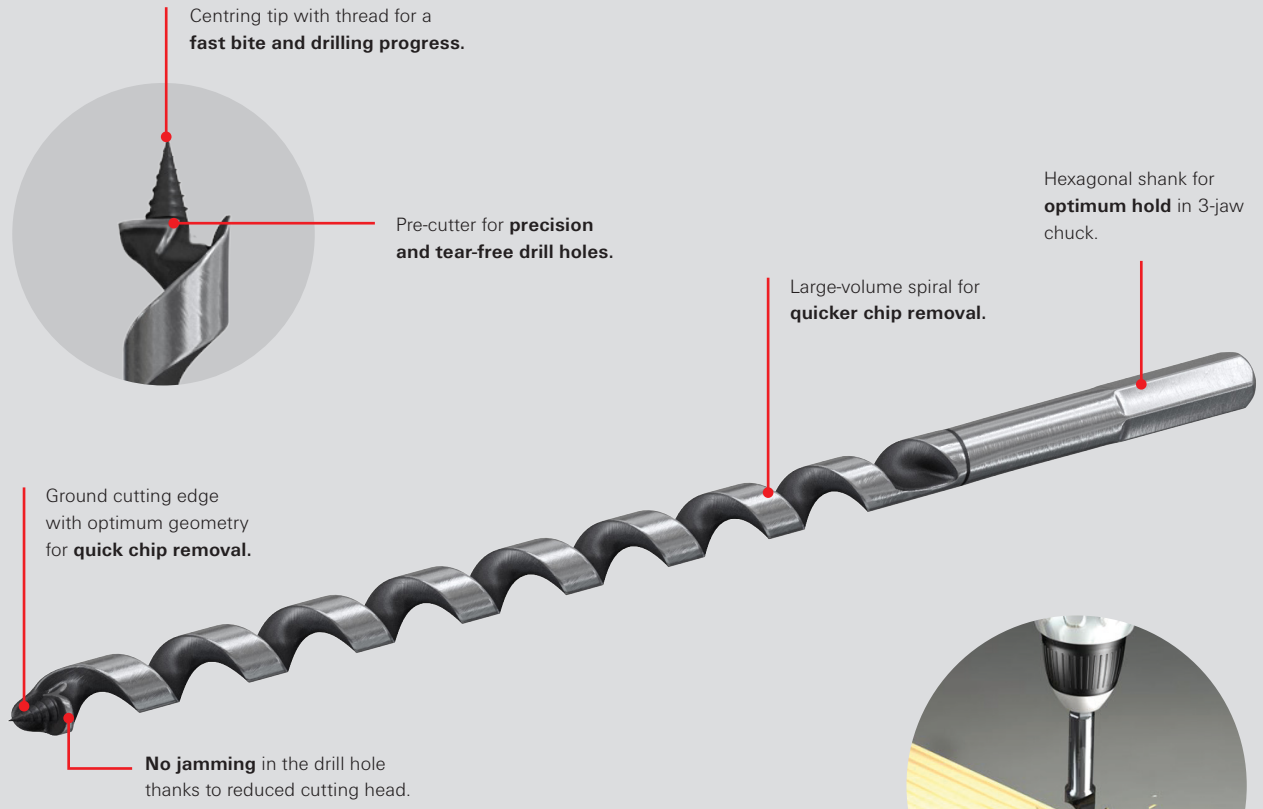

Your benefits at a glance

- Centring tip with thread for a fast bite and drilling progress.
- Ground cutting edge with optimum geometry for quick chip removal.
- Pre-cutters for precision and tear-free drill holes.
- Long service life thanks to hardened head- and main cutting edges.
- No jamming in the drill hole thanks to reduced cutting head.
- Large-volume spiral for quickest chip removal.
- Hexagonal shank for optimum hold and no slipping in the 3-jaw chuck.

Recommendation



Hard- and soft wood, beams



Lightweight construction materials



Forstner drill bit D-WFo

Forstner drill bit toothed with centring tip and reduced straight shank

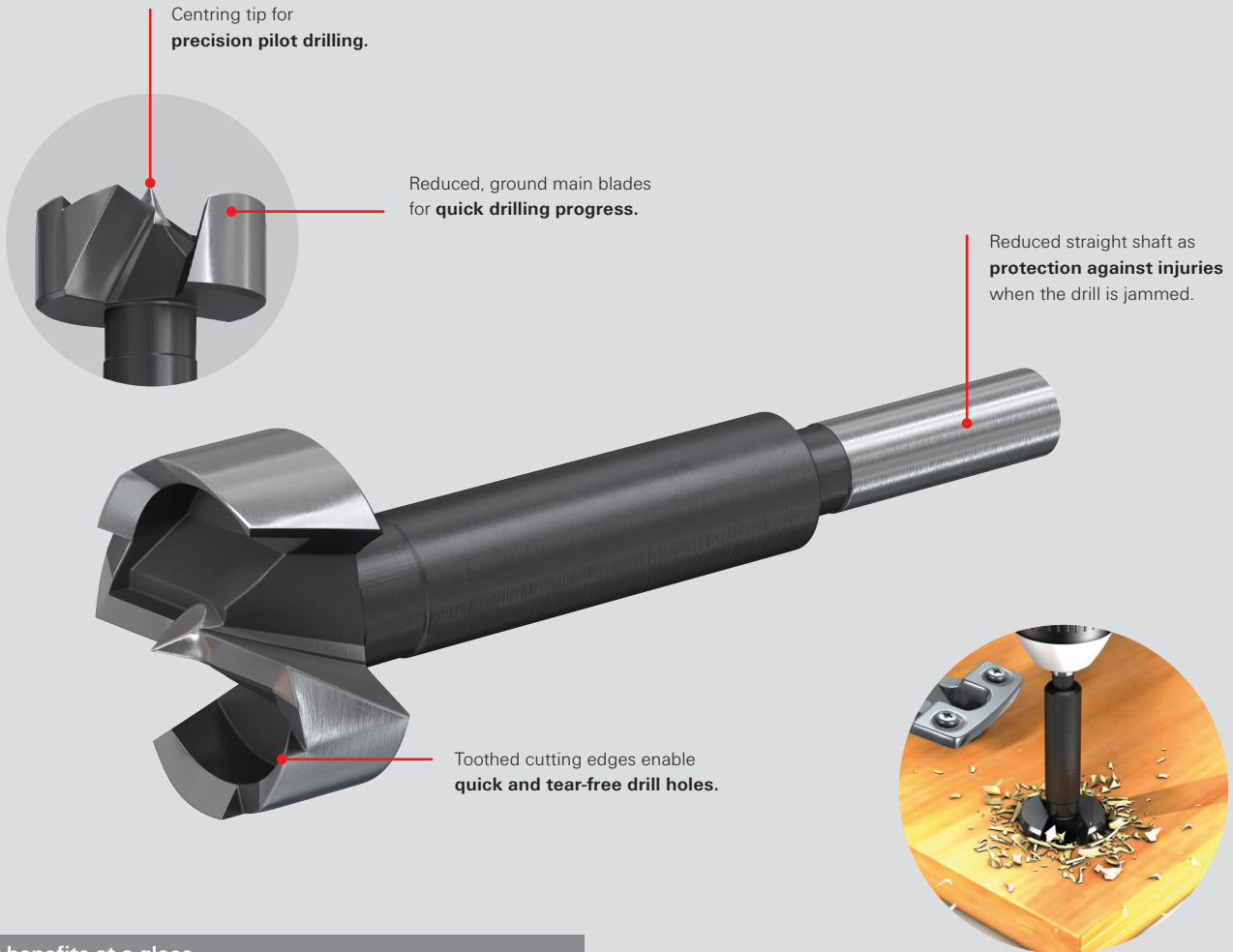

Your benefits at a glance

- Toothed cutting edges ensure quick and tear-free drill holes.
- Reduced, ground main cutting edges for quick drilling progress.
- Centring tip for precision pilot drilling.
- Reduced straight shaft as protection against injuries when the drill is jammed



Recommendation



Hard- and soft wood,
veneered boards



Lightweight
construction materials

Diamond hole saw HS-Di

Self-cooling diamond hole saw for extra-hard tiles

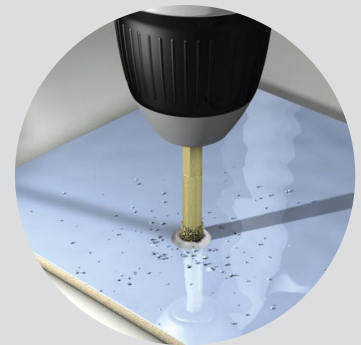
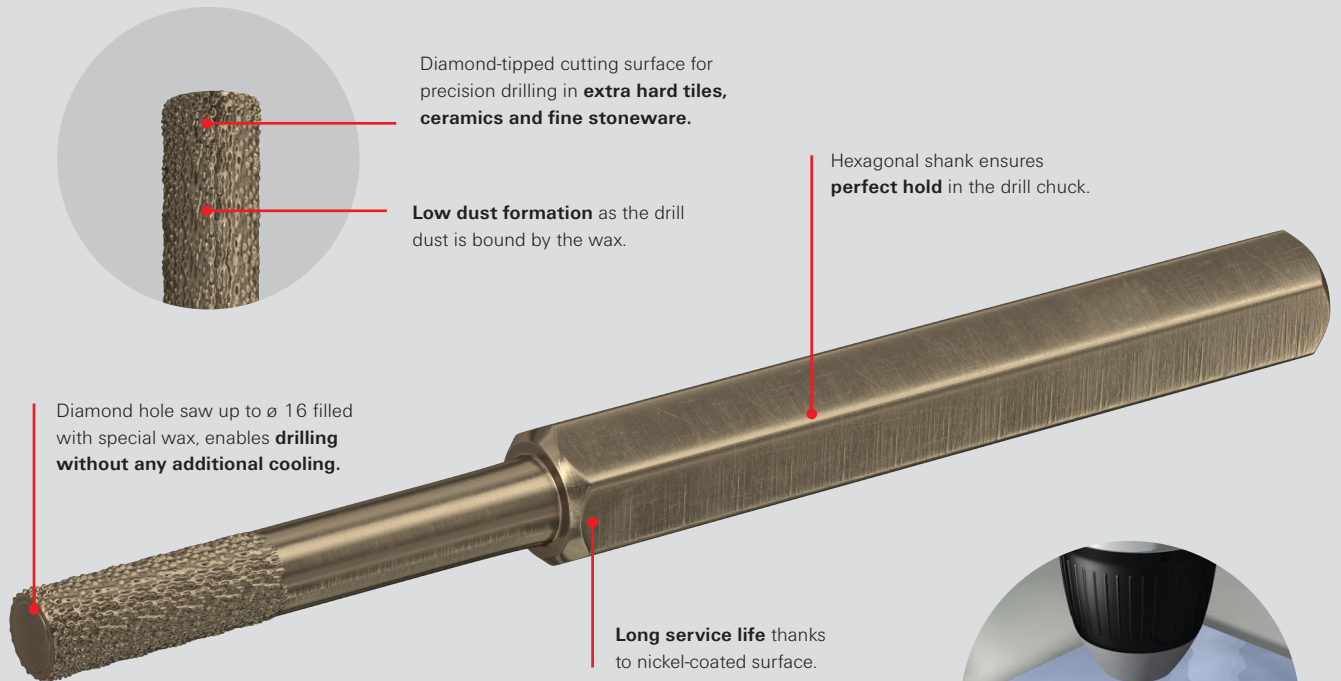

Your benefits at a glance

- Diamond-tipped cutting edge for quick drilling progress.
- Nickel-coated surface for long service life.
- Diamond drill bit filled with special wax binds the drill dust and ensures for low dust formation.
- Hexagonal shank ensures good hold without slipping in the drill chuck.
- Problem solver for drilling hard tiles.
- Precision drilling without damaging the material.
- No contamination with cooling liquid.



Recommendation



Tile

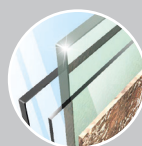

Glas



Stone

Bi-metal hole saw HS-HSS-Co

Cobalt-alloyed bi-metal hole saw

Faster work progress
through optimized toothing.

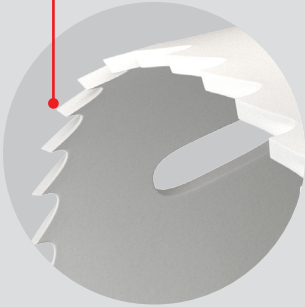

Positive tooth angle for
low-vibration sawing.

Quick sawing through
variable toothing with
4 - 6 teeth per inch.

Long service life thanks
to 8 % cobalt-alloyed
cutting teeth.



Special-alloy high carbon
steel body **for precise**
and perfectly round holes.

UNF-thread for **quick**
hole saw exchange.



Your benefits at a glance

- Long service life through 8 % cobalt-alloyed cutting teeth.
- Quick sawing progress through variable toothing with 4 - 6 teeth per inch.
- Creation of precision holes up to 38 mm cutting depth in various materials.
- UNF thread for quick hole saw exchange.
- Positive tooth angle for low-vibration sawing.



Recommendation

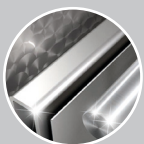

Stainless steel

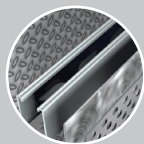

Metal

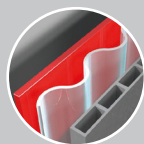

Plastic

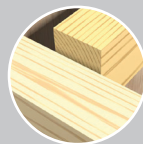

Wood

Quick-change adapter HS-A1 / A2

Adapter with centring drill bit HSS for bi-metal hole saws HS-HSS-Co

135° tip angle for quick drilling progress.

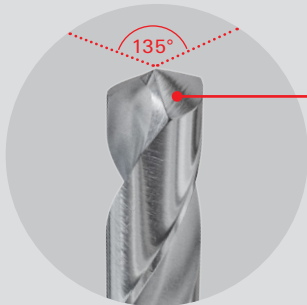

Split point for optimum centring and little feed force effort.



Adapter with hexagonal shank for optimal hold in the drill chuck.

Adapter is equipped with a quick-change function for quick hole saw exchange.

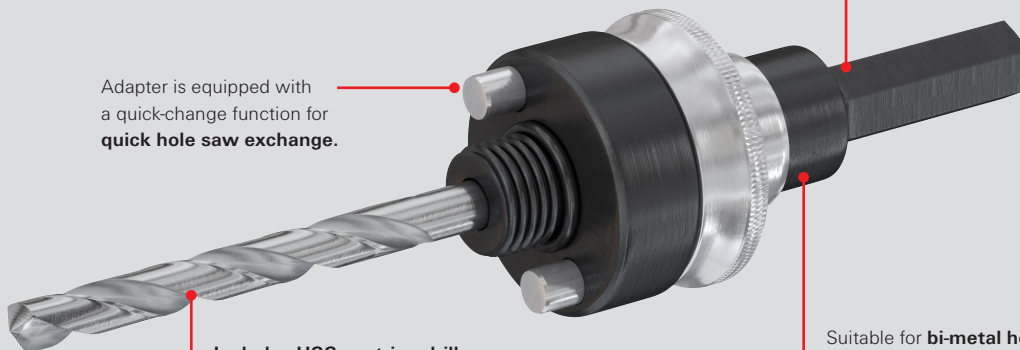

Includes HSS centring drill 90 mm and hexagonal key.

Suitable for bi-metal hole saws HS-HSS-Co.

Your benefits at a glance

- Adapter with hexagonal shank for optimal hold in the drill chuck.
- Suitable for bi-metal hole saws HS-HSS-Co.
- Adapter with quick-change function for hole saws (diameter 32 – 210 mm).
- Includes HSS centring drill 90 mm and hexagonal key.



Recommendation

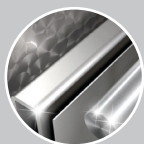

Stainless steel

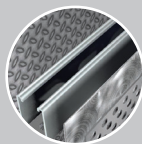

Metal

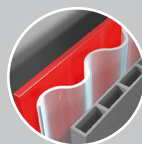

Plastic

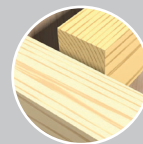

Wood

Multi-hole saw HS-Multi

Multi-hole saw with carbide cutting edges for wood and panel building materials

Carbide cutting edges (HM TCT) for **quick drilling progress** and **long service life**.

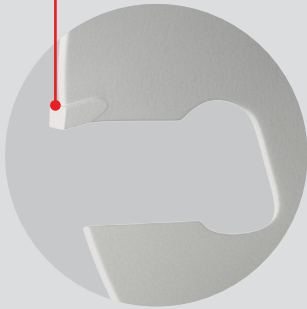

High-quality hole saw ensures **precise, clean and perfectly round holes**.



UNF-thread for **quick hole saw exchange**.

Carbide tipped for universal application and a **long service life**.

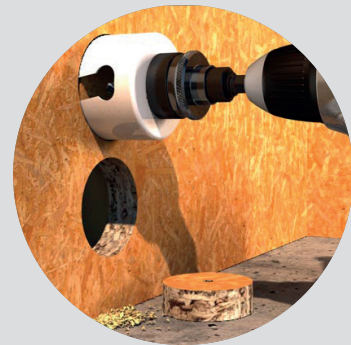

Your benefits at a glance

- Carbide cutting edges for quick drilling progress and long service life.
- Universally applicable in woods, panel building materials and vertically perforated bricks.
- UNF thread for quick hole saw exchange.

HM
TCT

Recommendation



Wood

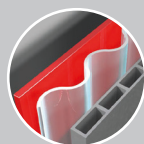

Plastic



Masonry

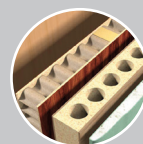

Lightweight
construction materials

Quick-change adapter HS – A1 / A2 S

Adapter with centring drill bit TCT for hole saw HS-Multi

130° carbide tip for long **service life**,
extremely heat resistant.

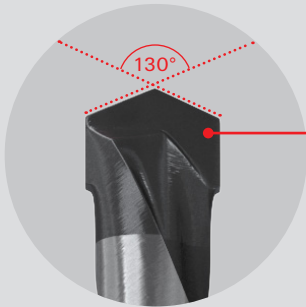

Including centring drill bit
D-C concrete 110 mm.



Adapter is equipped with a
quick-change function for
quick hole saw exchange.

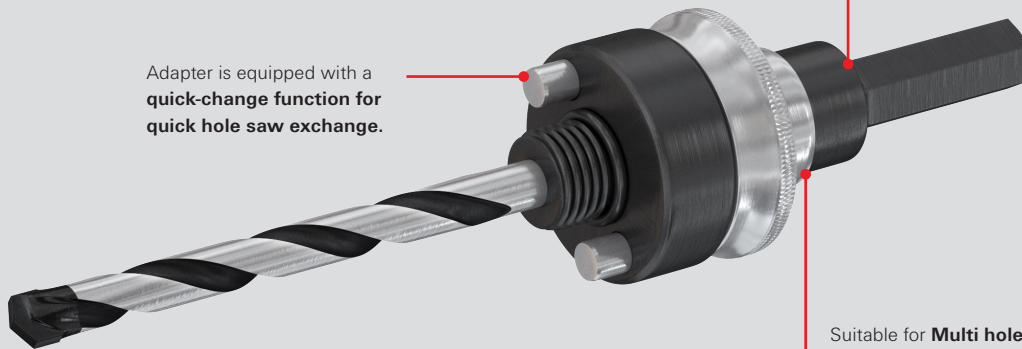

Adapter with hexagonal shank for
optimal hold in the drill chuck.

Suitable for **Multi hole**
saws **HS-Multi**.

Your benefits at a glance

- Adapter with hexagonal shank for optimal hold in the drill chuck.
- Suitable for HS-Multi hole saws.
- Adapter with quick-change function for hole saws (diameter 32 – 210 mm).
- Includes TCT centring drill 110 mm and hexagonal key.

HM
TCT



Recommendation



Wood

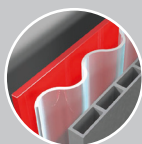

Plastic



Masonry

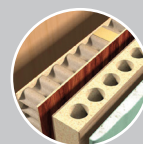

Lightweight
construction materials

Assortment

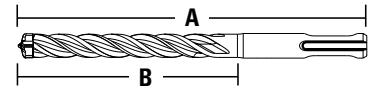

Hammer drill Quattric II

Item	Diameter [mm]	Total length (A) [mm]	Working length (B) [mm]	Option 1 Pouch			Option 2 Blister card			Option 3 Clip / Tube / Box		
				Art.-No.	Contents	Packaging	Art.-No.	Contents	Packaging	Art.-No.	Contents	Packaging
Quattric II 5/50/115	5,0	115	50	-	-	-	-	-	-	549973	1	Clip
Quattric II 5/100/165	5,0	165	100	-	-	-	-	-	-	549974	1	Clip
Quattric II 5,5/50/115	5,5	115	50	-	-	-	-	-	-	549971	1	Clip
Quattric II 5,5/100/165	5,5	165	100	-	-	-	-	-	-	549972	1	Clip
Quattric II 6/50/115	6,0	115	50	-	-	-	-	-	-	549983	1	Clip
Quattric II 6/100/165	6,0	165	100	-	-	-	-	-	-	549979	1	Clip
Quattric II 6/150/215	6,0	215	150	-	-	-	-	-	-	549981	1	Clip
Quattric II 6/200/265	6,0	265	200	-	-	-	-	-	-	549985	1	Clip
Quattric II 6/250/315	6,0	315	250	-	-	-	-	-	-	549986	1	Clip
Quattric II 6,5/100/165	6,5	165	100	-	-	-	-	-	-	549975	1	Clip
Quattric II 6,5/150/215	6,5	215	150	-	-	-	-	-	-	549976	1	Clip
Quattric II 6,5/200/265	6,5	265	200	-	-	-	-	-	-	549977	1	Clip
Quattric II 6,5/250/315	6,5	315	250	-	-	-	-	-	-	549978	1	Clip
Quattric II 7/100/165	7,0	165	100	-	-	-	-	-	-	549987	1	Clip
Quattric II 8/50/115	8,0	115	50	-	-	-	-	-	-	549993	1	Clip
Quattric II 8/100/165	8,0	165	100	-	-	-	-	-	-	549988	1	Clip
Quattric II 8/150/215	8,0	215	150	-	-	-	-	-	-	549990	1	Clip
Quattric II 8/200/265	8,0	265	200	-	-	-	-	-	-	549994	1	Clip
Quattric II 8/250/315	8,0	315	250	-	-	-	-	-	-	549992	1	Clip
Quattric II 8/300/365	8,0	365	300	-	-	-	-	-	-	549995	1	Clip
Quattric II 8/400/465	8,0	465	400	-	-	-	-	-	-	549996	1	Clip
Quattric II 10/50/115	10,0	115	50	-	-	-	-	-	-	549928	1	Clip
Quattric II 10/100/165	10,0	165	100	-	-	-	-	-	-	549922	1	Clip
Quattric II 10/150/215	10,0	215	150	-	-	-	-	-	-	549925	1	Clip
Quattric II 10/200/265	10,0	265	200	-	-	-	-	-	-	549929	1	Clip
Quattric II 10/250/315	10,0	315	250	-	-	-	-	-	-	549927	1	Clip
Quattric II 10/390/455	10,0	455	390	-	-	-	-	-	-	549930	1	Clip
Quattric II 12/110/160	12,0	160	110	-	-	-	-	-	-	549932	1	Clip
Quattric II 12/160/210	12,0	210	160	-	-	-	-	-	-	549936	1	Clip
Quattric II 12/210/260	12,0	260	210	-	-	-	-	-	-	549934	1	Clip
Quattric II 12/260/310	12,0	310	260	-	-	-	-	-	-	549939	1	Clip
Quattric II 12/400/450	12,0	450	400	-	-	-	-	-	-	549935	1	Clip
Quattric II 12/950/1000	12,0	1000	950	-	-	-	-	-	-	549931	1	Clip
Quattric II 14/110/160	14,0	160	110	-	-	-	-	-	-	549941	1	Clip
Quattric II 14/160/210	14,0	210	160	-	-	-	-	-	-	549944	1	Clip
Quattric II 14/210/260	14,0	260	210	-	-	-	-	-	-	549942	1	Clip
Quattric II 14/260/310	14,0	310	260	-	-	-	-	-	-	549945	1	Clip
Quattric II 14/400/450	14,0	450	400	-	-	-	-	-	-	549943	1	Clip
Quattric II 14/950/1000	14,0	1000	950	-	-	-	-	-	-	549940	1	Clip
Quattric II 15/110/160	15,0	160	110	-	-	-	-	-	-	549946	1	Clip
Quattric II 15/160/210	15,0	210	160	-	-	-	-	-	-	549947	1	Clip
Quattric II 16/110/160	16,0	160	110	-	-	-	-	-	-	549950	1	Clip
Quattric II 16/160/210	16,0	210	160	-	-	-	-	-	-	549951	1	Clip
Quattric II 16/210/260	16,0	260	210	-	-	-	-	-	-	549952	1	Clip
Quattric II 16/260/310	16,0	310	260	-	-	-	-	-	-	549953	1	Clip
Quattric II 16/400/450	16,0	450	400	-	-	-	-	-	-	549954	1	Clip
Quattric II 16/550/600	16,0	600	550	-	-	-	-	-	-	549955	1	Clip
Quattric II 16/950/1000	16,0	1000	950	-	-	-	-	-	-	549948	1	Clip
Quattric II 18/200/250	18,0	250	200	-	-	-	-	-	-	549956	1	Tube
Quattric II 18/400/450	18,0	450	400	-	-	-	-	-	-	549957	1	Tube

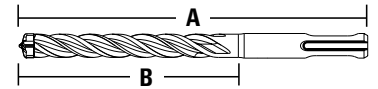

Hammer drill Quattric II

Item	Diameter [mm]	Total length (A) [mm]	Working length (B) [mm]	Option 1 Pouch			Option 2 Blister card			Option 3 Clip / Tube / Box		
				Art.-No.	Contents	Packaging	Art.-No.	Contents	Packaging	Art.-No.	Contents	Packaging
Quattric II 20/200/250	20,0	250	200	–	–	–	–	–	–	549958	1	Tube
Quattric II 20/400/450	20,0	450	400	–	–	–	–	–	–	549959	1	Tube
Quattric II 22/200/250	22,0	250	200	–	–	–	–	–	–	549960	1	Tube
Quattric II 22/400/450	22,0	450	400	–	–	–	–	–	–	549961	1	Tube
Quattric II 24/200/250	24,0	250	200	–	–	–	–	–	–	549962	1	Tube
Quattric II 24/400/450	24,0	450	400	–	–	–	–	–	–	549963	1	Tube
Quattric II 25/200/250	25,0	250	200	–	–	–	–	–	–	549964	1	Tube
Quattric II 25/400/450	25,0	450	400	–	–	–	–	–	–	549965	1	Tube
Quattric II 28/200/250	28,0	250	200	–	–	–	–	–	–	549966	1	Tube
Quattric II 28/400/450	28,0	450	400	–	–	–	–	–	–	549967	1	Tube
Quattric II 30/200/250	30,0	250	200	–	–	–	–	–	–	549968	1	Tube
Quattric II 30/400/450	30,0	450	400	–	–	–	–	–	–	549969	1	Tube
Quattric II 32/400/450	32,0	450	400	–	–	–	–	–	–	549970	1	Tube
Quattric II 6/50/115 XP5	6,0	115	50	–	–	–	–	–	–	549984	5	Box
Quattric II 6/100/165 XP10	6,0	165	100	–	–	–	–	–	–	549980	10	Box
Quattric II 6/150/215 XP5	6,0	215	150	–	–	–	–	–	–	549982	5	Box
Quattric II 8/100/165 XP5	8,0	165	100	–	–	–	–	–	–	549989	5	Box
Quattric II 8/150/215 XP5	8,0	215	150	–	–	–	–	–	–	549991	5	Box
Quattric II 10/100/165 XP10	10,0	165	100	–	–	–	–	–	–	549923	10	Box
Quattric II 10/100/165 XP5	10,0	165	100	–	–	–	–	–	–	549924	5	Box
Quattric II 10/150/215 XP5	10,0	215	150	–	–	–	–	–	–	549926	5	Box
Quattric II 12/110/160 XP5	12,0	160	110	–	–	–	–	–	–	549933	5	Box
Quattric II 12/160/210 XP5	12,0	210	160	–	–	–	–	–	–	549937	5	Box
Quattric II 12/210/260 XP5	12,0	260	210	–	–	–	–	–	–	549938	5	Box

Assortment

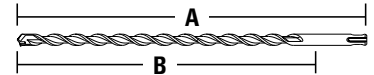

Hammer drill SDS Plus II Pointer

Item	Diameter [mm]	Total length (A) [mm]	Working length (B) [mm]	Option 1 Pouch			Option 2 Blister card			Option 3 Clip / Tube / Box		
				Art.-No.	Contents	Packaging	Art.-No.	Contents	Packaging	Art.-No.	Contents	Packaging
SDS Plus II 4/50/110	4,0	110	50	–	–	–	–	–	–	531753	1	Clip
SDS Plus II 4/100/160	4,0	160	100	–	–	–	–	–	–	531754	1	Clip
SDS Plus II 5/50/110	5,0	110	50	–	–	–	–	–	–	531755	1	Clip
SDS Plus II 5/100/160	5,0	160	100	–	–	–	–	–	–	531756	1	Clip
SDS Plus II 5/150/210	5,0	210	150	–	–	–	–	–	–	531757	1	Clip
SDS Plus II 5/250/310	5,0	310	250	–	–	–	–	–	–	531759	1	Clip
SDS Plus II 5,5/100/160	5,5	160	100	–	–	–	–	–	–	531761	1	Clip
SDS Plus II 5,5/150/210	5,5	210	150	–	–	–	–	–	–	531762	1	Clip
SDS Plus II 5,5/250/310	4,0	110	50	–	–	–	–	–	–	531763	1	Clip
SDS Plus II 6/50/110	6,0	110	50	–	–	–	–	–	–	531765	1	Clip
SDS Plus II 6/100/160	6,0	160	100	–	–	–	–	–	–	531766	1	Clip
SDS Plus II 6/150/210	6,0	210	150	–	–	–	–	–	–	531767	1	Clip
SDS Plus II 6/200/260	6,0	260	200	–	–	–	–	–	–	531768	1	Clip
SDS Plus II 6/250/310	6,0	310	250	–	–	–	–	–	–	531769	1	Clip
SDS Plus II 6,5/50/110	6,5	110	50	–	–	–	–	–	–	531770	1	Clip
SDS Plus II 6,5/100/160	6,5	160	100	–	–	–	–	–	–	531771	1	Clip
SDS Plus II 6,5/150/210	6,5	210	150	–	–	–	–	–	–	531772	1	Clip
SDS Plus II 6,5/200/260	6,5	260	200	–	–	–	–	–	–	531773	1	Clip
SDS Plus II 6,5/250/310	6,5	310	250	–	–	–	–	–	–	531774	1	Clip
SDS Plus II 7/50/110	7,0	110	50	–	–	–	–	–	–	531775	1	Clip
SDS Plus II 7/100/160	7,0	160	100	–	–	–	–	–	–	531776	1	Clip
SDS Plus II 7/150/210	7,0	210	150	–	–	–	–	–	–	531777	1	Clip
SDS Plus II 7/200/250	7,0	250	200	–	–	–	–	–	–	531778	1	Clip
SDS Plus II 8/50/110	8,0	110	50	–	–	–	–	–	–	531779	1	Clip
SDS Plus II 8/100/160	8,0	160	100	–	–	–	–	–	–	531780	1	Clip
SDS Plus II 8/150/210	8,0	210	150	–	–	–	–	–	–	531781	1	Clip
SDS Plus II 8/200/260	8,0	260	200	–	–	–	–	–	–	531782	1	Clip
SDS Plus II 8/250/310	8,0	310	250	–	–	–	–	–	–	531783	1	Clip
SDS Plus II 8/350/400	8,0	400	350	–	–	–	–	–	–	531784	1	Clip
SDS Plus II 8/400/460	8,0	460	400	–	–	–	–	–	–	531785	1	Clip
SDS Plus II 8/550/600	8,0	600	550	–	–	–	–	–	–	531786	1	Clip
SDS Plus II 9/100/160	9,0	160	100	–	–	–	–	–	–	531788	1	Clip
SDS Plus II 9/150/210	9,0	210	150	–	–	–	–	–	–	531789	1	Clip
SDS Plus II 9,5/100/160	9,0	160	100	–	–	–	–	–	–	531790	1	Clip
SDS Plus II 10/50/110	10,0	110	50	–	–	–	–	–	–	531791	1	Clip
SDS Plus II 10/100/160	10,0	160	100	–	–	–	–	–	–	531792	1	Clip
SDS Plus II 10/150/210	10,0	210	150	–	–	–	–	–	–	531793	1	Clip
SDS Plus II 10/200/260	10,0	260	200	–	–	–	–	–	–	531794	1	Clip
SDS Plus II 10/250/310	10,0	310	250	–	–	–	–	–	–	531795	1	Clip
SDS Plus II 10/300/350	10,0	350	300	–	–	–	–	–	–	531796	1	Clip
SDS Plus II 10/400/450	10,0	450	400	–	–	–	–	–	–	531797	1	Clip
SDS Plus II 10/550/600	10,0	600	550	–	–	–	–	–	–	531798	1	Clip
SDS Plus II 10/750/800	10,0	800	750	–	–	–	–	–	–	531799	1	Clip
SDS Plus II 10/950/1000	10,0	1000	950	–	–	–	–	–	–	531800	1	Clip
SDS Plus II 11/100/160	11,0	160	100	–	–	–	–	–	–	531801	1	Clip
SDS Plus II 11/250/310	11,0	310	250	–	–	–	–	–	–	531802	1	Clip
SDS Plus II 12/100/160	12,0	160	100	–	–	–	–	–	–	531803	1	Clip
SDS Plus II 12/150/210	12,0	210	150	–	–	–	–	–	–	531804	1	Clip
SDS Plus II 12/200/260	12,0	260	200	–	–	–	–	–	–	531805	1	Clip
SDS Plus II 12/250/310	12,0	310	250	–	–	–	–	–	–	531806	1	Clip

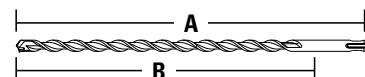

Hammer drill SDS Plus II Pointer

Item	Diameter	Total length (A)	Working length (B)	Option 1 Pouch			Option 2 Blister card			Option 3 Clip / Tube / Box		
	[mm]	[mm]	[mm]	Art.-No.	Contents	Packaging	Art.-No.	Contents	Packaging	Art.-No.	Contents	Packaging
SDS Plus II 12/300/360	12,0	360	300	–	–	–	–	–	–	531807	1	Clip
SDS Plus II 12/400/450	12,0	450	400	–	–	–	–	–	–	531808	1	Clip
SDS Plus II 12/550/600	12,0	600	550	–	–	–	–	–	–	531809	1	Clip
SDS Plus II 12/950/1000	12,0	1000	950	–	–	–	–	–	–	531810	1	Clip
SDS Plus II 13/100/160	13,0	160	100	–	–	–	–	–	–	531811	1	Clip
SDS Plus II 13/150/210	13,0	210	150	–	–	–	–	–	–	531812	1	Clip
SDS Plus II 13/200/260	13,0	260	200	–	–	–	–	–	–	531813	1	Clip
SDS Plus II 13/250/310	13,0	310	250	–	–	–	–	–	–	531814	1	Clip
SDS Plus II 14/100/160	14,0	160	100	–	–	–	–	–	–	531815	1	Clip
SDS Plus II 14/150/210	14,0	210	150	–	–	–	–	–	–	531816	1	Clip
SDS Plus II 14/200/260	14,0	260	200	–	–	–	–	–	–	531817	1	Clip
SDS Plus II 14/250/310	14,0	310	250	–	–	–	–	–	–	531818	1	Clip
SDS Plus II 14/400/450	14,0	450	400	–	–	–	–	–	–	531819	1	Clip
SDS Plus II 14/550/600	14,0	600	550	–	–	–	–	–	–	531820	1	Clip
SDS Plus II 14/950/1000	14,0	1000	950	–	–	–	–	–	–	531821	1	Clip
SDS Plus II 15/100/160	15,0	160	100	–	–	–	–	–	–	531822	1	Clip
SDS Plus II 15/150/210	15,0	210	150	–	–	–	–	–	–	531823	1	Clip
SDS Plus II 15/200/260	15,0	260	200	–	–	–	–	–	–	531824	1	Clip
SDS Plus II 15/400/450	15,0	450	400	–	–	–	–	–	–	531825	1	Clip
SDS Plus II 16/100/160	16,0	160	100	–	–	–	–	–	–	531826	1	Clip
SDS Plus II 16/150/210	16,0	210	150	–	–	–	–	–	–	531827	1	Clip
SDS Plus II 16/200/260	16,0	260	200	–	–	–	–	–	–	531828	1	Clip
SDS Plus II 16/250/310	16,0	310	250	–	–	–	–	–	–	531829	1	Clip
SDS Plus II 16/400/450	16,0	450	400	–	–	–	–	–	–	531830	1	Clip
SDS Plus II 16/550/600	16,0	600	550	–	–	–	–	–	–	531831	1	Clip
SDS Plus II 16/750/800	16,0	800	750	–	–	–	–	–	–	531832	1	Clip
SDS Plus II 16/950/1000	16,0	1000	950	–	–	–	–	–	–	531833	1	Clip
SDS Plus II 17/150/210	17,0	210	150	–	–	–	–	–	–	531834	1	Clip
SDS Plus II 17/400/450	17,0	450	400	–	–	–	–	–	–	531835	1	Clip
SDS Plus II 18/150/200	18,0	200	150	–	–	–	–	–	–	531836	1	Clip
SDS Plus II 18/250/300	18,0	300	250	–	–	–	–	–	–	531837	1	Clip
SDS Plus II 18/400/450	18,0	450	400	–	–	–	–	–	–	531838	1	Clip
SDS Plus II 18/550/600	18,0	600	550	–	–	–	–	–	–	531839	1	Clip
SDS Plus II 18/950/1000	18,0	1000	950	–	–	–	–	–	–	531840	1	Clip
SDS Plus II 19/150/200	19,0	200	150	–	–	–	–	–	–	531841	1	Clip
SDS Plus II 19/400/450	19,0	450	400	–	–	–	–	–	–	531842	1	Clip
SDS Plus II 20/150/200	20,0	200	150	–	–	–	–	–	–	531843	1	Clip
SDS Plus II 20/250/300	20,0	300	250	–	–	–	–	–	–	531844	1	Clip
SDS Plus II 20/400/450	20,0	450	400	–	–	–	–	–	–	531845	1	Clip
SDS Plus II 20/550/600	20,0	600	550	–	–	–	–	–	–	531846	1	Clip
SDS Plus II 20/950/1000	20,0	1000	950	–	–	–	–	–	–	531847	1	Clip
SDS Plus II 22/200/250	22,0	250	200	–	–	–	–	–	–	531849	1	Clip
SDS Plus II 22/400/450	22,0	450	400	–	–	–	–	–	–	531850	1	Clip
SDS Plus II 22/550/600	22,0	600	550	–	–	–	–	–	–	531851	1	Clip
SDS Plus II 22/950/1000	22,0	1000	950	–	–	–	–	–	–	531852	1	Clip
SDS Plus II 24/200/250	24,0	250	200	–	–	–	–	–	–	531853	1	Clip
SDS Plus II 24/400/450	24,0	450	400	–	–	–	–	–	–	531854	1	Clip
SDS Plus II 25/200/250	25,0	250	200	–	–	–	–	–	–	531855	1	Clip
SDS Plus II 25/400/450	25,0	450	400	–	–	–	–	–	–	531856	1	Clip
SDS Plus II 25/550/600	25,0	600	550	–	–	–	–	–	–	531857	1	Clip

Assortment

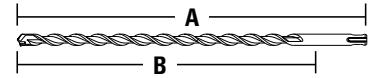

Hammer drill SDS Plus II Pointer

Item	Diameter [mm]	Total length (A) [mm]	Working length (B) [mm]	Option 1 Pouch			Option 2 Blister card			Option 3 Clip / Tube / Box		
				Art.-No.	Contents	Packaging	Art.-No.	Contents	Packaging	Art.-No.	Contents	Packaging
SDS Plus II 26/200/250	26,0	250	200	–	–	–	–	–	–	531858	1	Clip
SDS Plus II 26/400/450	26,0	450	400	–	–	–	–	–	–	531859	1	Clip
SDS Plus II 6/50/110 QP	6,0	110	50	–	–	–	–	–	–	531860	10	Box
SDS Plus II 6/100/160 QP	6,0	160	100	–	–	–	–	–	–	531861	10	Box
SDS Plus II 8/100/160 QP	8,0	160	100	–	–	–	–	–	–	531862	10	Box
SDS Plus II 8/150/210 QP	8,0	210	150	–	–	–	–	–	–	531863	10	Box
SDS Plus II 10/100/160 QP	10,0	160	100	–	–	–	–	–	–	531864	10	Box
SDS Plus II 10/150/210 QP	10,0	210	150	–	–	–	–	–	–	531865	10	Box
SDS Plus II 10/200/260 QP	10,0	260	200	–	–	–	–	–	–	531866	10	Box
SDS Plus II 10/250/310 QP	10,0	310	250	–	–	–	–	–	–	531867	10	Box
SDS Plus II 12/100/160 QP	12,0	160	100	–	–	–	–	–	–	531868	10	Box
SDS Plus II 12/150/210 QP	12,0	210	150	–	–	–	–	–	–	531869	10	Box
SDS Plus II 12/200/260 QP	12,0	260	200	–	–	–	–	–	–	531870	10	Box

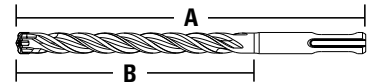

Hammer drill SDS Max II / SDS Max IV

Item	Diameter [mm]	Total length (A) [mm]	Working length (B) [mm]	Option 1 Pouch			Option 2 Blister card			Option 3 Clip / Tube / Box		
				Art.-No.	Contents	Packaging	Art.-No.	Contents	Packaging	Art.-No.	Contents	Packaging
SDS Max II 12/200/340	12,0	340	200	-	-	-	-	-	-	504188	1	Tube
SDS Max II 12/400/540	12,0	540	400	-	-	-	-	-	-	504189	1	Tube
SDS Max II 12/800/920	12,0	920	800	-	-	-	-	-	-	098278	1	Tube
SDS Max II 14/200/340	14,0	340	200	-	-	-	-	-	-	504192	1	Tube
SDS Max II 14/400/540	14,0	540	400	-	-	-	-	-	-	504194	1	Tube
SDS Max II 14/1000/1120	14,0	1120	1000	-	-	-	-	-	-	098279 ¹⁾	1	Tube
SDS Max II 15/200/340	15,0	340	200	-	-	-	-	-	-	504196	1	Tube
SDS Max IV 15/400/540	15,0	540	400	-	-	-	-	-	-	524562	1	Tube
SDS Max IV 16/200/340	16,0	340	200	-	-	-	-	-	-	504198	1	Tube
SDS Max IV 16/400/540	16,0	540	400	-	-	-	-	-	-	504199	1	Tube
SDS Max IV 16/800/920	16,0	920	800	-	-	-	-	-	-	504200	1	Tube
SDS Max IV 16/1200/1320	16,0	1320	1200	-	-	-	-	-	-	504206	1	Tube
SDS Max IV 18/200/340	18,0	340	200	-	-	-	-	-	-	504207	1	Tube
SDS Max IV 18/400/540	18,0	540	400	-	-	-	-	-	-	504208	1	Tube
SDS Max IV 18/800/920	18,0	920	800	-	-	-	-	-	-	504209	1	Tube
SDS Max IV 18/1200/1320	18,0	1320	1200	-	-	-	-	-	-	504213	1	Tube
SDS Max IV 20/200/320	20,0	320	200	-	-	-	-	-	-	504214	1	Tube
SDS Max IV 20/400/520	20,0	520	400	-	-	-	-	-	-	504217	1	Tube
SDS Max IV 20/800/920	20,0	920	800	-	-	-	-	-	-	504222	1	Tube
SDS Max IV 20/1200/1320	20,0	1320	1200	-	-	-	-	-	-	504223	1	Tube
SDS Max IV 22/200/320	22,0	320	200	-	-	-	-	-	-	504224	1	Tube
SDS Max IV 22/400/520	22,0	520	400	-	-	-	-	-	-	504225	1	Tube
SDS Max IV 22/800/920	22,0	920	800	-	-	-	-	-	-	504226	1	Tube
SDS Max IV 24/200/320	24,0	320	200	-	-	-	-	-	-	504228	1	Tube
SDS Max IV 24/400/520	24,0	520	400	-	-	-	-	-	-	504229	1	Tube
SDS Max IV 25/200/320	25,0	320	200	-	-	-	-	-	-	504235	1	Tube
SDS Max IV 25/400/520	25,0	520	400	-	-	-	-	-	-	504236	1	Tube
SDS Max IV 25/800/920	25,0	920	800	-	-	-	-	-	-	504237	1	Tube
SDS Max IV 25/1200/1320	25,0	1320	1200	-	-	-	-	-	-	504238	1	Tube
SDS Max IV 25/2000/2120	25,0	2120	2000	-	-	-	-	-	-	098287 ¹⁾	1	Tube
SDS Max IV 28/250/370	28,0	370	250	-	-	-	-	-	-	504240	1	Tube
SDS Max IV 28/450/570	28,0	570	450	-	-	-	-	-	-	504241	1	Tube
SDS Max IV 28/550/670	28,0	670	550	-	-	-	-	-	-	504242	1	Tube
SDS Max IV 28/800/920	28,0	920	800	-	-	-	-	-	-	504243	1	Tube
SDS Max IV 30/250/370	30,0	370	250	-	-	-	-	-	-	504245	1	Tube
SDS Max IV 30/450/570	30,0	570	450	-	-	-	-	-	-	504246	1	Tube
SDS Max IV 30/800/920	30,0	920	800	-	-	-	-	-	-	057779 ¹⁾	1	Tube
SDS Max IV 30/1230/1350	30,0	1350	1210	-	-	-	-	-	-	040187 ¹⁾	1	Tube
SDS Max IV 30/1620/1740	30,0	1740	1620	-	-	-	-	-	-	040188 ¹⁾	1	Tube
SDS Max IV 30/2020/2140	30,0	2140	2000	-	-	-	-	-	-	040189 ¹⁾	1	Tube
SDS Max IV 32/450/570	32,0	570	450	-	-	-	-	-	-	504248	1	Tube
SDS Max IV 32/800/920	32,0	920	800	-	-	-	-	-	-	504249	1	Tube
SDS Max IV 35/250/370	35,0	370	250	-	-	-	-	-	-	504251	1	Tube
SDS Max IV 35/450/570	35,0	570	450	-	-	-	-	-	-	504256	1	Tube
SDS Max IV 35/550/670	35,0	670	550	-	-	-	-	-	-	504257	1	Tube
SDS Max IV 35/800/920	35,0	920	800	-	-	-	-	-	-	504258	1	Tube
SDS Max IV 35/1200/1320	35,0	1320	1200	-	-	-	-	-	-	504259	1	Tube
SDS Max IV 35/1620/1740	35,0	1740	1620	-	-	-	-	-	-	040191 ¹⁾	1	Tube
SDS Max IV 35/2020/2140	35,0	2140	2000	-	-	-	-	-	-	040192 ¹⁾	1	Tube
SDS Max IV 38/450/570	38,0	570	450	-	-	-	-	-	-	504268	1	Tube

1) Delivery time on demand

Assortment

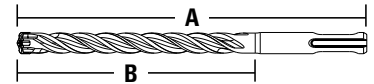

Hammer drill SDS Max II / SDS Max IV

Item	Diameter [mm]	Total length (A) [mm]	Working length (B) [mm]	Option 1 Pouch			Option 2 Blister card			Option 3 Clip / Tube / Box		
				Art.-No.	Contents	Packaging	Art.-No.	Contents	Packaging	Art.-No.	Contents	Packaging
SDS Max IV 40/250/370	40,0	370	250	–	–	–	–	–	–	504269	1	Tube
SDS Max IV 40/450/570	40,0	570	450	–	–	–	–	–	–	504270	1	Tube
SDS Max IV 40/800/920	40,0	920	800	–	–	–	–	–	–	504271	1	Tube



Sharp chisel



Flat chisel



Spade chisel



Gouge chisel



Channel chisel



Tile chisel



Wing bit



Tooth chisel

Chisels

Item	Type	Length [mm]	Width [mm]	Option 1 Pouch			Option 2 Blister card			Option 3 Clip / Tube / Box		
				Art.-No.	Contents	Packaging	Art.-No.	Contents	Packaging	Art.-No.	Contents	Packaging
SDS Plus Pointed 250	Sharp chisel	250	12	–	–	–	–	–	–	504277	1	Clip
SDS Max Pointed 280	Sharp chisel	280	16	–	–	–	–	–	–	504281	1	Clip
SDS Max Pointed 400	Sharp chisel	400	20	–	–	–	–	–	–	504282	1	Clip
SDS Max Pointed 600	Sharp chisel	600	27	–	–	–	–	–	–	504283	1	Clip
SDS Plus Flat 20/250	Flat chisel	250	20	–	–	–	–	–	–	504278	1	Clip
SDS Max Flat 25/280	Flat chisel	280	25	–	–	–	–	–	–	504284	1	Clip
SDS Max Flat 25/400	Flat chisel	400	25	–	–	–	–	–	–	504286	1	Clip
SDS Max Flat 25/600	Flat chisel	600	25	–	–	–	–	–	–	504287	1	Clip
SDS Plus Scaling 40/250	Spade chisel	250	40	–	–	–	–	–	–	504279	1	Clip
SDS Max Scaling 50/400	Spade chisel	400	50	–	–	–	–	–	–	504288	1	Clip
SDS Max Scaling 80/300	Spade chisel	300	80	–	–	–	–	–	–	504290	1	Clip
SDS Max Scaling 115/350	Spade chisel	350	115	–	–	–	–	–	–	504291	1	Clip
SDS Plus Hollow 22/250	Gouge chisel	250	22	–	–	–	–	–	–	504280	1	Clip
SDS Max Hollow 26/300	Gouge chisel	300	26	–	–	–	–	–	–	504293	1	Clip
SDS Max Canal 32/300	Channel chisel	300	32	–	–	–	–	–	–	504294	1	Clip
SDS Plus I M-Tile Scaling 40/250	Tile chisel	250	40	–	–	–	–	–	–	531437	1	Clip
SDS Max Tile Scaling 50/400	Tile chisel	400	50	–	–	–	–	–	–	504295	1	Clip
SDS Max with Glides 35/380	Wing bit	380	35	–	–	–	–	–	–	504296	1	Clip
SDS Max Slotting 32/300	Tooth chisel	300	32	–	–	–	–	–	–	504301	1	Clip



Concrete drill bit D-C

Item	Diameter [mm]	Total length (A) [mm]	Working length (B) [mm]	Option 1 Pouch			Option 2 Blister card			Option 3 Cassette / Tube		
				Art.-No.	Contents	Packaging	Art.-No.	Contents	Packaging	Art.-No.	Contents	Packaging
D-C 3,0x30/60	3,0	60	30	–	–	–	530575	2	Blister card	–	–	–
D-C 4,0x40/75	4,0	75	40	536563	2	Pouch	530576	2	Blister card	–	–	–
D-C 5,0x50/85	5,0	85	50	536564	1	Pouch	530577	1	Blister card	–	–	–
D-C 5,5x50/85	5,5	85	50	–	–	–	530578	1	Blister card	–	–	–
D-C 6,0x60/100	6,0	100	60	536565	1	Pouch	530579	1	Blister card	–	–	–
D-C 6,0x300/400	6,0	400	300	–	–	–	–	–	–	530580	1	Tube
D-C 7,0x60/100	7,0	100	60	–	–	–	530584	1	Blister card	–	–	–
D-C 8,0x80/120	8,0	120	80	536566	1	Pouch	530590	1	Blister card	–	–	–
D-C 8,0x135/200	8,0	200	135	–	–	–	–	–	–	551326	1	Tube
D-C 8,0x300/400	8,0	400	300	–	–	–	–	–	–	530591	1	Tube
D-C 9,0x80/120	9,0	120	80	–	–	–	530592	1	Blister card	–	–	–
D-C 10,0x80/120	10,0	120	80	536567	1	Pouch	530593	1	Blister card	–	–	–
D-C 10,0x135/200	10,0	200	135	–	–	–	–	–	–	551327	1	Tube
D-C 10,0x300/400	10,0	400	300	–	–	–	–	–	–	530595	1	Tube
D-C 11,0x85/150	11,0	150	85	–	–	–	530596	1	Blister card	–	–	–
D-C 12,0x85/150	12,0	150	85	536568	1	Pouch	530597	1	Blister card	–	–	–
D-C 12,0x135/200	12,0	200	135	–	–	–	–	–	–	551328	1	Tube
D-C 12,0x300/400	12,0	400	300	–	–	–	–	–	–	530600	1	Tube
D-C 14,0x85/150	14,0	150	85	536569	1	Pouch	530601	1	Blister card	–	–	–
D-C 16,0x85/150	16,0	150	85	536570	1	Pouch	530604	1	Blister card	–	–	–
D-C 18,0x105/160	18,0	160	105	–	–	–	530606	1	Blister card	–	–	–
D-C 20,0x105/160	20,0	160	105	–	–	–	530607	1	Blister card	–	–	–
D-C Set 4-10mm 5pcs P	4-5-6- 8-10 mm	–	–	–	–	–	–	–	–	536606	5	Plastic Cassette
D-C Set 3-10mm 8pcs P	3-10 mm	–	–	–	–	–	–	–	–	536607	8	Plastic Cassette

Assortment

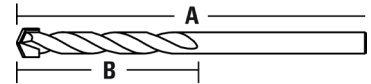

Masonry drill bit D-S

Item	Diameter [mm]	Total length (A) [mm]	Working length (B) [mm]	Option 1 Pouch			Option 2 Blister card			Option 3 Cassette / Tube		
				Art.-No.	Contents	Packaging	Art.-No.	Contents	Packaging	Art.-No.	Contents	Packaging
D-S HM 3,0x30/60	3,0	60	30	542976	1	Pouch	530522	2	Blister card	—	—	—
D-S HM 4,0x38/75	4,0	75	38	542977	1	Pouch	530523	2	Blister card	—	—	—
D-S HM 5,0x44/85	5,0	85	44	542978	1	Pouch	530524	1	Blister card	—	—	—
D-S HM 5,0x85/150	5,0	150	85	—	—	—	—	—	—	530525	1	Tube
D-S HM 6,0x54/100	6,0	100	54	542979	1	Pouch	530527	1	Blister card	—	—	—
D-S HM 6,0x85/150	6,0	150	85	—	—	—	—	—	—	530528	1	Tube
D-S HM 6,0x135/200	6,0	200	135	551390	1	Pouch	—	—	—	—	—	—
D-S HM 7,0x54/100	7,0	100	54	542980	1	Pouch	530552	1	Blister card	—	—	—
D-S HM 8,0x67/120	8,0	120	67	542981	1	Pouch	530553	1	Blister card	—	—	—
D-S HM 8,0x85/150	8,0	150	85	—	—	—	—	—	—	551386	1	Tube
D-S HM 8,0x135/200	8,0	200	135	542991	1	Pouch	—	—	—	530554	1	Tube
D-S HM 8,0x300/400	8,0	400	300	—	—	—	—	—	—	530555	1	Tube
D-S HM 8,0x450/600	8,0	600	450	—	—	—	—	—	—	551391	1	Tube
D-S HM 9,0x67/120	9,0	120	67	—	—	—	530556	1	Blister card	—	—	—
D-S HM 10,0x67/120	10,0	120	67	542982	1	Pouch	530557	1	Blister card	—	—	—
D-S HM 10,0x135/200	10,0	200	135	542992	1	Pouch	—	—	—	530558	1	Tube
D-S HM 10,0x300/400	10,0	400	300	—	—	—	—	—	—	530559	1	Tube
D-S HM 10,0x450/600	10,0	600	450	—	—	—	—	—	—	551392	1	Tube
D-S HM 11,0x85/150	11,0	150	85	—	—	—	530560	1	Blister card	—	—	—
D-S HM 12,0x85/150	12,0	150	85	542983	1	Pouch	530563	1	Blister card	—	—	—
D-S HM 12,0x135/200	12,0	200	135	542993	1	Pouch	—	—	—	530564	1	Tube
D-S HM 12,0x300/400	12,0	400	300	—	—	—	—	—	—	530565	1	Tube
D-S HM 12,0x450/600	12,0	600	450	—	—	—	—	—	—	551393	1	Tube
D-S HM 13,0x85/150	13,0	150	85	542984	1	Pouch	—	—	—	—	—	—
D-S HM 14,0x85/150	14,0	150	85	542985	1	Pouch	530566	1	Blister card	—	—	—
D-S HM 14,0x135/200	14,0	200	135	—	—	—	—	—	—	551394	1	Tube
D-S HM 14,0x300/400	14,0	400	300	—	—	—	—	—	—	530567	1	Tube
D-S HM 14,0x450/600	14,0	600	450	—	—	—	—	—	—	551395	1	Tube
D-S HM 15,0x85/150	15,0	150	85	542986	1	Pouch	530568	1	Blister card	—	—	—
D-S HM 16,0x85/150	16,0	150	85	542987	1	Pouch	530569	1	Blister card	—	—	—
D-S HM 16,0x135/200	16,0	200	135	—	—	—	—	—	—	551396	1	Tube
D-S HM 16,0x300/400	16,0	400	300	—	—	—	—	—	—	530570	1	Tube
D-S HM 16,0x450/600	16,0	600	450	—	—	—	—	—	—	551397	1	Tube
D-S HM 18,0x100/160	18,0	160	100	542988	1	Pouch	530571	1	Blister card	551387	1	Tube
D-S HM 18,0x300/400	18,0	400	300	—	—	—	—	—	—	530572	1	Tube
D-S HM 18,0x450/600	18,0	600	450	—	—	—	—	—	—	551398	1	Tube
D-S HM 20,0x100/160	20,0	160	100	542989	1	Pouch	530573	1	Blister card	551388	1	Tube
D-S HM 20,0x300/400	20,0	400	300	—	—	—	—	—	—	530574	1	Tube
D-S HM 20,0x450/600	20,0	600	450	—	—	—	—	—	—	551399	1	Tube
D-S HM 22,0x300/400	22,0	400	300	—	—	—	—	—	—	551400	1	Tube
D-S HM 24,0x300/400	24,0	400	300	—	—	—	—	—	—	551401	1	Tube
D-S HM 25,0x100/160	25,0	160	100	—	—	—	—	—	—	551389	1	Tube
D-S Set 4-10mm 5pcs P	4-5-6- 8-10 mm	—	—	—	—	—	—	—	—	543025	5	Plastic Cassette
D-S Set 3-10mm 8pcs P	3-10 mm	—	—	—	—	—	—	—	—	543027	8	Plastic Cassette

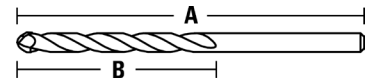

Universal drill bit Ultimate Drill D-U

Item	Diameter [mm]	Total length (A) [mm]	Working length (B) [mm]	Option 1 Pouch			Option 2 Blister card			Option 3 Clip / Tube / Box		
				Art.No.	Contents	Packaging	Art.No.	Contents	Packaging	Art.No.	Contents	Packaging
D-U 5,0x50/85	5,0	85	50	–	–	–	–	–	–	530623	1	Special Packaging
D-U 6,0x65/100	6,0	100	65	–	–	–	–	–	–	530624	1	Special Packaging
D-U 8,0x75/125	8,0	125	75	–	–	–	–	–	–	530626	1	Special Packaging

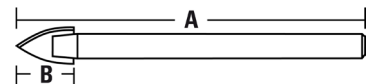

Glass drill bit D-GT

Item	Diameter [mm]	Total length (A) [mm]	Working length (B) [mm]	Option 1 Pouch			Option 2 Blister card			Option 3 Clip / Tube / Box		
				Art.No.	Contents	Packaging	Art.No.	Contents	Packaging	Art.No.	Contents	Packaging
D-GT 4,0x10/60	4,0	60	10	–	–	–	551342	2	Blister card	–	–	–
D-GT 5,0x11/70	5,0	70	11	–	–	–	551340	1	Blister card	–	–	–
D-GT 6,0x13/75	6,0	75	13	–	–	–	551341	1	Blister card	–	–	–
D-GT 8,0x14/80	8,0	80	14	–	–	–	551343	1	Blister card	–	–	–
D-GT 10,0x15/100	10,0	100	15	–	–	–	551344	1	Blister card	–	–	–

Assortment

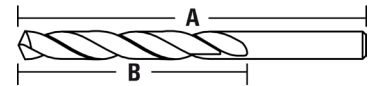

Metal drill bit D-HSS-Co

Item	Diameter [mm]	Total length (A) [mm]	Working length (B) [mm]	Option 1 Pouch			Option 2 Blister card			Option 3 X-Pack / Cassette		
				Art.-No.	Contents	Packaging	Art.-No.	Contents	Packaging	Art.-No.	Contents	Packaging
HSS-Co DIN338 1,0x12/34	1,0	34	12	—	—	—	530491	2	Blister card	—	—	—
HSS-Co DIN338 1,5x18/40	1,5	40	18	—	—	—	530492	2	Blister card	—	—	—
HSS-Co DIN338 2,0x24/49	2,0	49	24	536552	2	Pouch	530493	2	Blister card	—	—	—
HSS-Co DIN338 2,5x30/57	2,5	57	30	—	—	—	530494	2	Blister card	—	—	—
HSS-Co DIN338 3,0x33/61	3,0	61	33	536553	2	Pouch	530495	2	Blister card	—	—	—
HSS-Co DIN338 3,2x36/65	3,2	65	36	—	—	—	530496	2	Blister card	—	—	—
HSS-Co DIN338 3,5x39/70	3,5	70	39	—	—	—	530497	2	Blister card	—	—	—
HSS-Co DIN338 4,0x43/75	4,0	75	43	536554	2	Pouch	530498	2	Blister card	—	—	—
HSS-Co DIN338 4,2x43/75	4,2	75	43	—	—	—	530499	1	Blister card	—	—	—
HSS-Co DIN338 4,5x47/80	4,5	80	47	536555	1	Pouch	530504	1	Blister card	—	—	—
HSS-Co DIN338 5,0x52/86	5,0	86	52	536556	1	Pouch	530505	1	Blister card	—	—	—
HSS-Co DIN338 5,5x57/93	5,5	93	57	536557	1	Pouch	530506	1	Blister card	—	—	—
HSS-Co DIN338 6,0x57/93	6,0	93	57	536558	1	Pouch	530507	1	Blister card	—	—	—
HSS-Co DIN338 6,5x63/101	6,5	101	63	536559	1	Pouch	530508	1	Blister card	—	—	—
HSS-Co DIN338 7,0x69/109	7,0	109	69	536560	1	Pouch	530509	1	Blister card	—	—	—
HSS-Co DIN338 7,5x69/109	7,5	109	69	—	—	—	530510	1	Blister card	—	—	—
HSS-Co DIN338 8,0x75/117	8,0	117	75	536561	1	Pouch	530511	1	Blister card	—	—	—
HSS-Co DIN338 8,5x75/117	8,5	117	75	—	—	—	530512	1	Blister card	—	—	—
HSS-Co DIN338 9,0x81/125	9,0	125	81	—	—	—	530513	1	Blister card	—	—	—
HSS-Co DIN338 9,5x81/125	9,5	125	81	—	—	—	530514	1	Blister card	—	—	—
HSS-Co DIN338 10,0x87/133	10,0	133	87	536562	1	Pouch	530515	1	Blister card	—	—	—
HSS-Co DIN338 10,5x94/142	10,5	133	87	—	—	—	530516	1	Blister card	—	—	—
HSS-Co DIN338 11,0x94/142	11,0	142	94	—	—	—	530517	1	Blister card	—	—	—
HSS-Co DIN338 11,5x94/142	11,5	142	94	—	—	—	530518	1	Blister card	—	—	—
HSS-Co DIN338 12,0x101/151	12,0	151	101	—	—	—	530519	1	Blister card	—	—	—
HSS-Co DIN338 12,5x101/151	12,5	151	101	—	—	—	530520	1	Blister card	—	—	—
HSS-Co DIN338 13,0x101/151	13,0	151	101	—	—	—	530521	1	Blister card	—	—	—

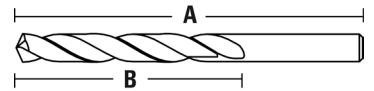

Metal drill bit D-HSS-G

Item	Diameter [mm]	Total length (A) [mm]	Working length (B) [mm]	Option 1 Pouch			Option 2 Blister card			Option 3 X-Pack / Cassette		
				Art-No.	Contents	Packaging	Art-No.	Contents	Packaging	Art-No.	Contents	Packaging
HSS-G DIN338 1,0x12/34	1,0	34	12	536516	5	Pouch	—	—	—	539200	10	X-Pack
HSS-G DIN338 1,5x18/40	1,5	40	18	536517	5	Pouch	—	—	—	539201	10	X-Pack
HSS-G DIN338 2,0x24/49	2,0	49	24	536518	2	Pouch	—	—	—	539202	10	X-Pack
HSS-G DIN338 2,5x30/57	2,5	57	30	536519	2	Pouch	—	—	—	539203	10	X-Pack
HSS-G DIN338 3,0x33/61	3,0	61	33	536524	2	Pouch	—	—	—	—	—	—
HSS-G DIN338 3,2x36/65	3,2	65	36	536529	2	Pouch	—	—	—	539204	10	X-Pack
HSS-G DIN338 3,5x39/70	3,5	70	39	536531	2	Pouch	—	—	—	539205	10	X-Pack
HSS-G DIN338 4,0x43/75	4,0	75	43	536532	2	Pouch	—	—	—	—	—	—
HSS-G DIN338 4,2x43/75	4,2	75	43	536533	1	Pouch	—	—	—	539206	10	X-Pack
HSS-G DIN338 4,5x47/80	4,5	80	47	536534	1	Pouch	—	—	—	539207	10	X-Pack
HSS-G DIN338 5,0x52/86	5,0	86	52	536535	1	Pouch	—	—	—	539208	10	X-Pack
HSS-G DIN338 5,5x57/93	5,5	93	57	536536	1	Pouch	—	—	—	539209	10	X-Pack
HSS-G DIN338 6,0x57/93	6,0	93	57	536537	1	Pouch	—	—	—	539210	10	X-Pack
HSS-G DIN338 6,5x63/101	6,5	101	63	536538	1	Pouch	—	—	—	539211	10	X-Pack
HSS-G DIN338 7,0x69/109	7,0	109	69	536539	1	Pouch	—	—	—	539212	10	X-Pack
HSS-G DIN338 7,5x69/109	7,5	109	69	536540	1	Pouch	—	—	—	539213	10	X-Pack
HSS-G DIN338 8,0x75/117	8,0	117	75	536541	1	Pouch	—	—	—	539214	5	X-Pack
HSS-G DIN338 8,5x75/117	8,5	117	75	536542	1	Pouch	—	—	—	539215	5	X-Pack
HSS-G DIN338 9,0x81/125	9,0	125	81	536543	1	Pouch	—	—	—	539216	5	X-Pack
HSS-G DIN338 9,5x81/125	9,5	125	81	536544	1	Pouch	—	—	—	539217	5	X-Pack
HSS-G DIN338 10,0x87/133	10,0	133	87	536545	1	Pouch	—	—	—	539218	5	X-Pack
HSS-G DIN338 10,5x87/133	10,5	133	87	536546	1	Pouch	—	—	—	539219	5	X-Pack
HSS-G DIN338 11,0x94/142	11,0	142	94	536547	1	Pouch	—	—	—	539220	5	X-Pack
HSS-G DIN338 11,5x94/142	11,5	142	94	536548	1	Pouch	—	—	—	539221	5	X-Pack
HSS-G DIN338 12,0x101/151	12,0	151	101	536549	1	Pouch	—	—	—	539222	5	X-Pack
HSS-G DIN338 12,5x101/151	12,5	151	101	536550	1	Pouch	—	—	—	539223	5	X-Pack
HSS-G DIN338 13,0x101/151	13,0	151	101	536551	1	Pouch	—	—	—	536602	6	X-Pack
HSS-G Set 2-8mm 6pcs P	2,0-8,0 mm	—	—	—	—	—	—	—	—	536602	6	Plastic Cassette
HSS-G Set 1-10mm 10pcs P	1,0-10,0 mm	—	—	—	—	—	—	—	—	536603	10	Plastic Cassette
HSS-G Set 1-10mm 19pcs M	1,0-10,0 mm	—	—	—	—	—	—	—	—	536604	19	Metal Cassette
HSS-G Set 1-13mm 25pcs M	1,0-13,0 mm	—	—	—	—	—	—	—	—	536605	25	Metal Cassette

Assortment



Metal drill bit D-HSS-R

Item	Diameter [mm]	Total length (A) [mm]	Working length (B) [mm]	Option 1 Pouch			Option 2 Blister card			Option 3 Clip / Tube / Box		
				Art.-No.	Contents	Packaging	Art.-No.	Contents	Packaging	Art.-No.	Contents	Packaging
HSS-R DIN338 1,0x12/34	1,0	34	12	–	–	–	530403	2	Blister card	–	–	–
HSS-R DIN338 1,5x18/40	1,5	40	18	–	–	–	530404	2	Blister card	–	–	–
HSS-R DIN338 2,0x24/49	2,0	49	24	–	–	–	530405	2	Blister card	–	–	–
HSS-R DIN338 2,5x30/57	2,5	57	30	–	–	–	530406	2	Blister card	–	–	–
HSS-R DIN338 3,0x33/61	3,0	61	33	–	–	–	530407	2	Blister card	–	–	–
HSS-R DIN338 3,2x36/65	3,2	65	36	–	–	–	530408	2	Blister card	–	–	–
HSS-R DIN338 3,5x39/70	3,5	70	39	–	–	–	530409	2	Blister card	–	–	–
HSS-R DIN338 4,0x43/75	4,0	75	43	–	–	–	530410	2	Blister card	–	–	–
HSS-R DIN338 4,2x43/75	4,2	75	43	–	–	–	530411	1	Blister card	–	–	–
HSS-R DIN338 4,5x47/80	4,5	80	47	–	–	–	530412	1	Blister card	–	–	–
HSS-R DIN338 5,0x52/86	5,0	86	52	–	–	–	530413	1	Blister card	–	–	–
HSS-R DIN338 5,2x52/86	5,2	86	52	–	–	–	530414	1	Blister card	–	–	–
HSS-R DIN338 5,5x57/93	5,5	93	57	–	–	–	530415	1	Blister card	–	–	–
HSS-R DIN338 6,0x57/93	6,0	93	57	–	–	–	530416	1	Blister card	–	–	–
HSS-R DIN338 6,5x63/101	6,5	101	63	–	–	–	530417	1	Blister card	–	–	–
HSS-R DIN338 7,0x69/109	7,0	109	69	–	–	–	530418	1	Blister card	–	–	–
HSS-R DIN338 8,0x75/117	8,0	117	75	–	–	–	530483	1	Blister card	–	–	–
HSS-R DIN338 8,5x75/117	8,5	117	75	–	–	–	530484	1	Blister card	–	–	–
HSS-R DIN338 9,0x81/125	9,0	125	81	–	–	–	530485	1	Blister card	–	–	–
HSS-R DIN338 9,5x81/125	9,5	125	81	–	–	–	530486	1	Blister card	–	–	–
HSS-R DIN338 10,0x87/133	10,0	133	87	–	–	–	530487	1	Blister card	–	–	–
HSS-R DIN338 11,0x94/142	11,0	142	94	–	–	–	530488	1	Blister card	–	–	–
HSS-R DIN338 12,0x101/151	12,0	151	101	–	–	–	530489	1	Blister card	–	–	–
HSS-R DIN338 13,0x101/151	13,0	151	101	–	–	–	530490	1	Blister card	–	–	–
HSS-R DIN338 14,0x108/160	14,0	160	108	–	–	–	–	–	–	536512	1	Tube
HSS-R DIN338 16,0x120/178	16,0	178	120	–	–	–	–	–	–	536513	1	Tube
HSS-R DIN338 18,0x130/191	18,0	191	130	–	–	–	–	–	–	536514	1	Tube
HSS-R DIN338 20,0x140/205	20,0	205	140	–	–	–	–	–	–	536515	1	Tube

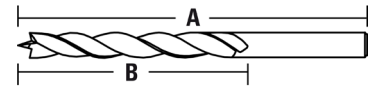

Wood drill bit D-WS

Item	Diameter [mm]	Total length (A) [mm]	Working length (B) [mm]	Option 1 Pouch			Option 2 Blister card			Option 3 Cassette / Tube		
				Art.-No.	Contents	Packaging	Art.-No.	Contents	Packaging	Art.-No.	Contents	Packaging
D-WS 3,0x33/61	3,0	61	33	536571	2	Pouch	530630	2	Blister card	–	–	–
D-WS 4,0x43/75	4,0	75	43	536572	2	Pouch	530634	2	Blister card	–	–	–
D-WS 5,0x52/86	5,0	86	52	536573	1	Pouch	530635	1	Blister card	–	–	–
D-WS 6,0x60/97	6,0	97	60	536574	1	Pouch	530636	1	Blister card	–	–	–
D-WS 7,0x70/110	7,0	109	69	536575	1	Pouch	–	–	–	–	–	–
D-WS 8,0x75/117	8,0	117	75	536576	1	Pouch	530638	1	Blister card	–	–	–
D-WS 9,0x80/125	9,0	125	80	536577	1	Pouch	–	–	–	–	–	–
D-WS 10,0x87/133	10,0	133	87	536578	1	Pouch	530639	1	Blister card	–	–	–
D-WS 12,0x96/151	12,0	151	96	536579	1	Pouch	530640	1	Blister card	–	–	–
D-WS 13,0x96/151	13,0	151	96	536580	1	Pouch	–	–	–	–	–	–
D-WS 14,0x97/151	14,0	151	97	536581	1	Pouch	551329	1	Blister card	–	–	–
D-WS Set 4-10mm 5pcs P	4-5-6-8- 10 mm	–	–	–	–	–	–	–	–	536608	5	Plastic Cassette
D-WS Set 3-10mm 8pcs P	3 - 10 mm	–	–	–	–	–	–	–	–	536609	8	Plastic Cassette

Assortment

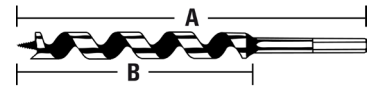

Auger bit D-WL

Item	Diameter [mm]	Total length (A) [mm]	Working length (B) [mm]	Option 1 Pouch			Option 2 Blister card			Option 3 Box / Tube		
				Art.-No.	Contents	Packaging	Art.-No.	Contents	Packaging	Art.-No.	Contents	Packaging
D-WL 6,0x155/230	6,0	230	155	—	—	—	—	—	—	551330	1	Tube
D-WL 8,0x155/230	8,0	230	155	—	—	—	—	—	—	551331	1	Tube
D-WL 10,0x155/230	10,0	230	155	—	—	—	—	—	—	551332	1	Tube
D-WL 12,0x155/230	12,0	230	155	—	—	—	—	—	—	549997	1	Tube
D-WL 14,0x155/230	14,0	230	155	—	—	—	—	—	—	549998	1	Tube
D-WL 16,0x155/230	16,0	230	155	—	—	—	—	—	—	549999	1	Tube
D-WL 18,0x155/230	18,0	230	155	—	—	—	—	—	—	551000	1	Tube
D-WL 20,0x155/230	20,0	230	155	—	—	—	—	—	—	551001	1	Tube
D-WL 22,0x155/230	22,0	230	155	—	—	—	—	—	—	551002	1	Tube
D-WL 24,0x155/230	24,0	230	155	—	—	—	—	—	—	551003	1	Tube
D-WL 26,0x155/230	26,0	230	155	—	—	—	—	—	—	551004	1	Tube
D-WL 28,0x155/230	28,0	230	155	—	—	—	—	—	—	551005	1	Tube
D-WL 30,0x155/230	30,0	230	155	—	—	—	—	—	—	551006	1	Tube
D-WL 32,0x155/230	32,0	230	155	—	—	—	—	—	—	551007	1	Tube
D-WL 6,0x245/320	6,0	320	245	—	—	—	—	—	—	551008	1	Tube
D-WL 8,0x245/320	8,0	320	245	—	—	—	—	—	—	551009	1	Tube
D-WL 10,0x245/320	10,0	320	245	—	—	—	—	—	—	551010	1	Tube
D-WL 12,0x245/320	12,0	320	245	—	—	—	—	—	—	551011	1	Tube
D-WL 14,0x245/320	14,0	320	245	—	—	—	—	—	—	551012	1	Tube
D-WL 16,0x245/320	16,0	320	245	—	—	—	—	—	—	551013	1	Tube
D-WL 18,0x245/320	18,0	320	245	—	—	—	—	—	—	551014	1	Tube
D-WL 20,0x245/320	20,0	320	245	—	—	—	—	—	—	551015	1	Tube
D-WL 22,0x245/320	22,0	320	245	—	—	—	—	—	—	551018	1	Tube
D-WL 24,0x245/320	24,0	320	245	—	—	—	—	—	—	551019	1	Tube
D-WL 26,0x245/320	26,0	320	245	—	—	—	—	—	—	551021	1	Tube
D-WL 28,0x245/320	28,0	320	245	—	—	—	—	—	—	551033	1	Tube
D-WL 30,0x245/320	30,0	320	245	—	—	—	—	—	—	551034	1	Tube
D-WL 32,0x245/320	32,0	320	245	—	—	—	—	—	—	551042	1	Tube
D-WL 6,0x385/460	6,0	460	385	—	—	—	—	—	—	551050	1	Tube
D-WL 8,0x385/460	8,0	460	385	—	—	—	—	—	—	551402	1	Tube
D-WL 10,0x385/460	10,0	460	385	—	—	—	—	—	—	551403	1	Tube
D-WL 12,0x385/460	12,0	460	385	—	—	—	—	—	—	551333	1	Tube
D-WL 14,0x385/460	14,0	460	385	—	—	—	—	—	—	551334	1	Tube
D-WL 16,0x385/460	16,0	460	385	—	—	—	—	—	—	551335	1	Tube
D-WL 18,0x385/460	18,0	460	385	—	—	—	—	—	—	551404	1	Tube
D-WL 20,0x385/460	20,0	460	385	—	—	—	—	—	—	551336	1	Tube
D-WL 22,0x385/460	22,0	460	385	—	—	—	—	—	—	551405	1	Tube
D-WL 24,0x385/460	24,0	460	385	—	—	—	—	—	—	551406	1	Tube
D-WL 26,0x385/460	26,0	460	385	—	—	—	—	—	—	551407	1	Tube
D-WL 28,0x385/460	28,0	460	385	—	—	—	—	—	—	551408	1	Tube
D-WL 30,0x385/460	30,0	460	385	—	—	—	—	—	—	551409	1	Tube
D-WL 32,0x385/460	32,0	460	385	—	—	—	—	—	—	551410	1	Tube
D-WL 8,0x530/600	8,0	600	530	—	—	—	—	—	—	551411	1	Tube
D-WL 10,0x530/600	10,0	600	530	—	—	—	—	—	—	551412	1	Tube
D-WL 12,0x530/600	12,0	600	530	—	—	—	—	—	—	551413	1	Tube
D-WL 14,0x530/600	14,0	600	530	—	—	—	—	—	—	551414	1	Tube
D-WL 16,0x530/600	16,0	600	530	—	—	—	—	—	—	551415	1	Tube
D-WL 18,0x530/600	18,0	600	530	—	—	—	—	—	—	551416	1	Tube
D-WL 20,0x530/600	20,0	600	530	—	—	—	—	—	—	551417	1	Tube

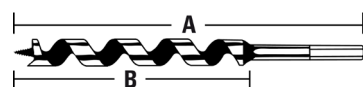

Auger bit D-WL

Item	Diameter [mm]	Total length (A) [mm]	Working length (B) [mm]	Option 1 Pouch			Option 2 Blister card			Option 3 Box / Tube		
				Art.-No.	Contents	Packaging	Art.-No.	Contents	Packaging	Art.-No.	Contents	Packaging
D-WL 22,0x530/600	22,0	600	530	-	-	-	-	-	-	551418	1	Tube
D-WL 24,0x530/600	24,0	600	530	-	-	-	-	-	-	551419	1	Tube
D-WL 26,0x530/600	26,0	600	530	-	-	-	-	-	-	551420	1	Tube
D-WL 28,0x530/600	28,0	600	530	-	-	-	-	-	-	551421	1	Tube
D-WL 30,0x530/600	30,0	600	530	-	-	-	-	-	-	551422	1	Tube
D-WL 32,0x530/600	32,0	600	530	-	-	-	-	-	-	551423	1	Tube
D-WL Set 230 6 pcs.	10-12-14-16-18-20	230	155	-	-	-	-	-	-	551424	6	Wood Box
D-WL Set 320 6 pcs	10-12-14-16-18-20	320	245	-	-	-	-	-	-	551425	6	Wood Box
D-WL Set 460 6 pcs	10-12-14-16-18-20	460	385	-	-	-	-	-	-	551426	6	Wood Box
D-WL Set 600 6 pcs	10-12-14-16-18-20	600	530	-	-	-	-	-	-	551427	6	Wood Box

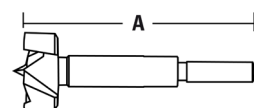

Forstner drill bit D-WFo

Item	Diameter [mm]	Total length (A) [mm]	Working length (B) [mm]	Option 1 Pouch			Option 2 Blister card			Option 3 X-Pack / Box / Tube		
				Art.-No.	Contents	Packaging	Art.-No.	Contents	Packaging	Art.-No.	Contents	Packaging
D-WFo 10,0mm	10,0	90,0	-	-	-	-	-	-	551428	1	Tube	
D-WFo 12,0mm	12,0	90,0	-	-	-	-	-	-	551429	1	Tube	
D-WFo 14,0mm	14,0	90,0	-	-	-	-	-	-	551430	1	Tube	
D-WFo 15,0mm	15,0	90,0	-	-	-	-	-	-	551431	1	Tube	
D-WFo 16,0mm	16,0	90,0	-	-	-	-	-	-	551432	1	Tube	
D-WFo 18,0mm	18,0	90,0	-	-	-	-	-	-	551433	1	Tube	
D-WFo 20,0mm	20,0	90,0	-	-	-	-	-	-	551434	1	Tube	
D-WFo 22,0mm	22,0	90,0	-	-	-	-	-	-	551435	1	Tube	
D-WFo 24,0mm	24,0	90,0	-	-	-	-	-	-	551436	1	Tube	
D-WFo 25,0mm	25,0	90,0	-	-	-	-	-	-	551337	1	Tube	
D-WFo 26,0mm	26,0	90,0	-	-	-	-	-	-	551437	1	Tube	
D-WFo 28,0mm	28,0	90,0	-	-	-	-	-	-	551438	1	Tube	
D-WFo 30,0mm	30,0	90,0	-	-	-	-	-	-	551338	1	Tube	
D-WFo 32,0mm	32,0	90,0	-	-	-	-	-	-	551439	1	Tube	
D-WFo 35,0mm	35,0	90,0	-	-	-	-	-	-	551339	1	Tube	
D-WFo 38,0mm	38,0	90,0	-	-	-	-	-	-	551440	1	X-Pack	
D-WFo 40,0mm	40,0	90,0	-	-	-	-	-	-	551441	1	X-Pack	
D-WFo Set 5pcs	15-20-25-30-35	90,0	-	-	-	-	-	-	551442	5	Wood Box	

Assortment

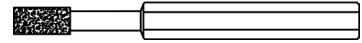
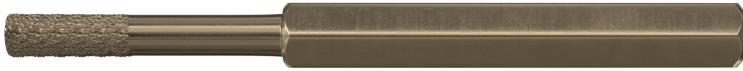

Diamond hole saw HS-Di

Item	Diameter [mm]	Total length (A) [mm]	Working length (B) [mm]	Option 1 Pouch			Option 2 Blister card			Option 3 Clip / Tube / Box		
				Art.-No.	Contents	Packaging	Art.-No.	Contents	Packaging	Art.-No.	Contents	Packaging
HS-Di 5,0	5,0	–	–	–	–	–	–	–	–	551345	1	Tube
HS-Di 6,0	6,0	–	–	–	–	–	–	–	–	551346	1	Tube
HS-Di 8,0	8,0	–	–	–	–	–	–	–	–	551347	1	Tube
HS-Di 10,0	10,0	–	–	–	–	–	–	–	–	551348	1	Tube
HS-Di 12,0	12,0	–	–	–	–	–	–	–	–	551349	1	Tube
HS-Di 14,0	14,0	–	–	–	–	–	–	–	–	551350	1	Tube

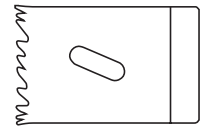

Bi-metal hole saw HS-HSS-Co

Item	Diameter [mm]	Total length (A) [mm]	Working length (B) [mm]	Option 1 Pouch			Option 2 Blister card			Option 3 Clip / Tube / Box		
				Art.-No.	Contents	Packaging	Art.-No.	Contents	Packaging	Art.-No.	Contents	Packaging
HS-HSS-Co 16,0	16,0	–	–	–	–	–	531996	1	Blister card	–	–	–
HS-HSS-Co 19,0	19,0	–	–	–	–	–	531999	1	Blister card	–	–	–
HS-HSS-Co 20,0	20,0	–	–	–	–	–	532001	1	Blister card	–	–	–
HS-HSS-Co 21,0	21,0	–	–	–	–	–	532002	1	Blister card	–	–	–
HS-HSS-Co 22,0	22,0	–	–	–	–	–	532004	1	Blister card	–	–	–
HS-HSS-Co 25,0	25,0	–	–	–	–	–	532007	1	Blister card	–	–	–
HS-HSS-Co 27,0	27,0	–	–	–	–	–	532009	1	Blister card	–	–	–
HS-HSS-Co 29,0	29,0	–	–	–	–	–	532010	1	Blister card	–	–	–
HS-HSS-Co 30,0	30,0	–	–	–	–	–	532012	1	Blister card	–	–	–
HS-HSS-Co 32,0	32,0	–	–	–	–	–	532013	1	Blister card	–	–	–
HS-HSS-Co 33,0	33,0	–	–	–	–	–	532015	1	Blister card	–	–	–
HS-HSS-Co 35,0	35,0	–	–	–	–	–	532016	1	Blister card	–	–	–
HS-HSS-Co 38,0	38,0	–	–	–	–	–	532018	1	Blister card	–	–	–
HS-HSS-Co 40,0	40,0	–	–	–	–	–	532019	1	Blister card	–	–	–
HS-HSS-Co 44,0	44,0	–	–	–	–	–	532022	1	Blister card	–	–	–
HS-HSS-Co 46,0	46,0	–	–	–	–	–	532023	1	Blister card	–	–	–
HS-HSS-Co 48,0	48,0	–	–	–	–	–	532024	1	Blister card	–	–	–
HS-HSS-Co 51,0	51,0	–	–	–	–	–	532025	1	Blister card	–	–	–
HS-HSS-Co 54,0	54,0	–	–	–	–	–	532028	1	Blister card	–	–	–
HS-HSS-Co 57,0	57,0	–	–	–	–	–	532029	1	Blister card	–	–	–
HS-HSS-Co 60,0	60,0	–	–	–	–	–	532032	1	Blister card	–	–	–
HS-HSS-Co 64,0	64,0	–	–	–	–	–	532033	1	Blister card	–	–	–
HS-HSS-Co 65,0	65,0	–	–	–	–	–	532034	1	Blister card	–	–	–
HS-HSS-Co 67,0	67,0	–	–	–	–	–	532035	1	Blister card	–	–	–
HS-HSS-Co 68,0	68,0	–	–	–	–	–	532036	1	Blister card	–	–	–
HS-HSS-Co 70,0	70,0	–	–	–	–	–	532037	1	Blister card	–	–	–
HS-HSS-Co 76,0	76,0	–	–	–	–	–	532042	1	Blister card	–	–	–
HS-HSS-Co 79,0	79,0	–	–	–	–	–	532043	1	Blister card	–	–	–
HS-HSS-Co 83,0	83,0	–	–	–	–	–	532044	1	Blister card	–	–	–

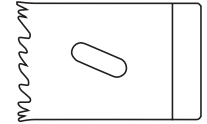

Bi-metal hole saw HS-HSS-Co

Item	Diameter [mm]	Total length (A) [mm]	Working length (B) [mm]	Option 1 Pouch			Option 2 Blister card			Option 3 Clip / Tube / Box		
				Art.-No.	Contents	Packaging	Art.-No.	Contents	Packaging	Art.-No.	Contents	Packaging
HS-HSS-Co 86,0	86,0	–	–	–	–	–	532046	1	Blister card	–	–	–
HS-HSS-Co 102,0	102,0	–	–	–	–	–	532054	1	Blister card	–	–	–
HS-HSS-Co 108,0	108,0	–	–	–	–	–	534248	1	Carton + EU Clip	–	–	–
HS-HSS-Co 111,0	111,0	–	–	–	–	–	534249	1	Carton + EU Clip	–	–	–
HS-HSS-Co 114,0	114,0	–	–	–	–	–	534251	1	Carton + EU Clip	–	–	–
HS-HSS-Co 127,0	127,0	–	–	–	–	–	532055	1	Carton + EU Clip	–	–	–
HS-HSS-Co 152,0	152,0	–	–	–	–	–	532056	1	Carton + EU Clip	–	–	–
HS-HSS-Co 160,0	160,0	–	–	–	–	–	534252	1	Carton + EU Clip	–	–	–
HS-HSS-Co 200,0	200,0	–	–	–	–	–	534253	1	Carton + EU Clip	–	–	–
HS-HSS-Co 210,0	210,0	–	–	–	–	–	534254	1	Carton + EU Clip	–	–	–
Complete Adpater HS-HSS-Co A1	–	–	–	–	–	–	–	–	–	532057	1	Tube
Complete Adpater HS-HSS-Co A2	–	–	–	–	–	–	–	–	–	532058	1	Tube

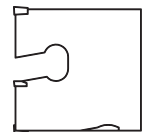

Multi-hole saw HS-Multi

Item	Diameter [mm]	Total length (A) [mm]	Working length (B) [mm]	Option 1 Pouch			Option 2 Blister card			Option 3 Clip / Tube / Box		
				Art.-No.	Contents	Packaging	Art.-No.	Contents	Packaging	Art.-No.	Contents	Packaging
HS-Multi 20,0	20,0	–	–	–	–	–	551351	1	Blister card	–	–	–
HS-Multi 25,0	25,0	–	–	–	–	–	551353	1	Blister card	–	–	–
HS-Multi 30,0	30,0	–	–	–	–	–	551354	1	Blister card	–	–	–
HS-Multi 35,0	35,0	–	–	–	–	–	551358	1	Blister card	–	–	–
HS-Multi 40,0	40,0	–	–	–	–	–	551360	1	Blister card	–	–	–
HS-Multi 51,0	51,0	–	–	–	–	–	551361	1	Blister card	–	–	–
HS-Multi 60,0	60,0	–	–	–	–	–	551362	1	Blister card	–	–	–
HS-Multi 68,0	68,0	–	–	–	–	–	551363	1	Blister card	–	–	–
HS-Multi 83,0	83,0	–	–	–	–	–	551364	1	Blister card	–	–	–
HS-Multi 89,0	89,0	–	–	–	–	–	551365	1	Blister card	–	–	–
HS-Multi 102,0	102,0	–	–	–	–	–	551366	1	Blister card	–	–	–
Complete Adpater HS-Multi A1 S	–	–	–	–	–	–	–	–	–	551367	1	Tube
Complete Adpater HS-Multi A2 S	–	–	–	–	–	–	–	–	–	551368	1	Tube

fischer FIXPERIENCE

The design and information software suite



- The modular design program includes engineering software and application modules.
- The software is based on international design standards (ETAG 001 and EC2, such as EC1, EC3 and EC5), including the national application documents. All common force and measurement units are available.
- Incorrect input will be recognized and the software gives tips to get a correct result. This ensures a safe and reliable design every time.
- The graphical display can easily be rotated through 360°, panned, tilted or zoomed as required.
- The 3D display gives a detailed and realistic image.
- The "live update" feature helps to keep the program up to date ensuring you are always working with the latest version.
- Free download and updates at www.fischer.de/fixperience-en

Our service to you



We are available to you at any time as a reliable partner to offer technical support and advice:

- Our products range from chemical resin systems to steel anchors through to nylon anchors.
- Competence and innovation through own research, development and production.
- Global presence and active sales service in over 100 countries.
- Qualified technical consulting for economical and compliant fastening solutions. Also on-site at the construction site if requested.
- Training sessions, some with accreditation, at your premises or at the fischer ACADEMY.
- Design and construction software for demanding applications.

This is what fischer stands for



FIXING SYSTEMS



AUTOMOTIVE SYSTEMS



FISCHERTECHNIK



CONSULTING

See the extensive main catalogue or visit our website at www.fischer.de for information about the complete fischer range